

JOTA

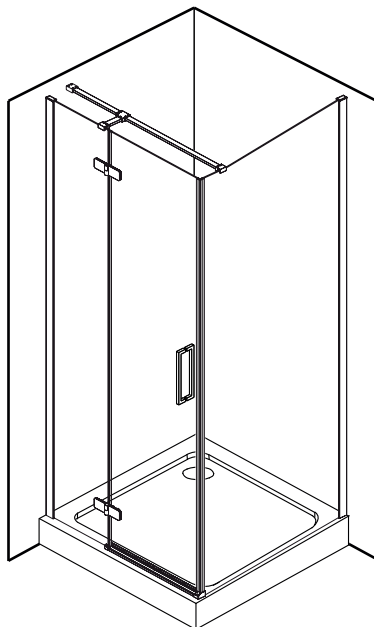

PL INSTRUKCJA MONTAŻU I EKSPLOATACJI

CZ NÁVOD NA MONTÁŽ A ÚDRŽBU

SK NÁVOD NA MONTÁŽ A ÚDRŽBU

EST PAIGALDUS- JA KASUTUSJUHEND

LT MONTAVIMO IR EKSPLOATAVIMO INSTRUKCIJA

LV MONTĀŽAS UN EKSPLUATĀCIJAS INSTRUKCIJA

DE MONTAGE- UND AUFBAUANLEITUNG

RO INSTRUCȚIUNI DE MONTAJ ȘI OPERARE

HU SZERELÉSI ÉS ÜZEMELTETÉSI ÚTMUTATÓ

UA ІНСТРУКЦІЯ З МОНТАЖУ І ЕКСПЛУАТАЦІЇ

BY ІНСТРУКЦЫЯ ПА МАНТАЖЫ І ЭКСПЛУАТАЦЫІ

RU ИНСТРУКЦИЯ ПО МОНТАЖУ И ЭКСПЛУАТАЦИИ

EN INSTRUCTIONS FOR ASSEMBLY AND USE

FR INSTALLATION ET UTILISATION - MODE

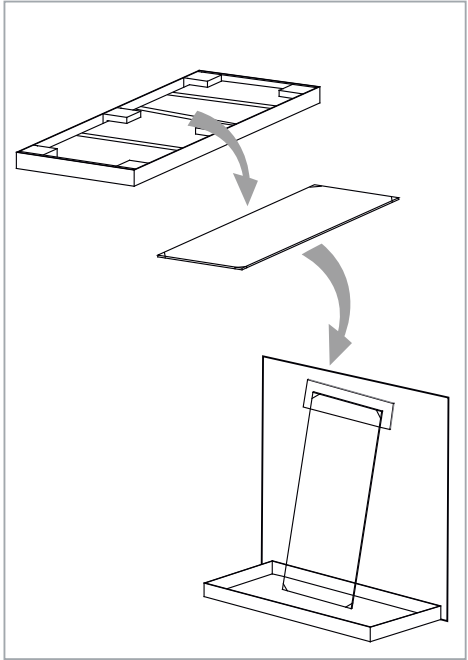
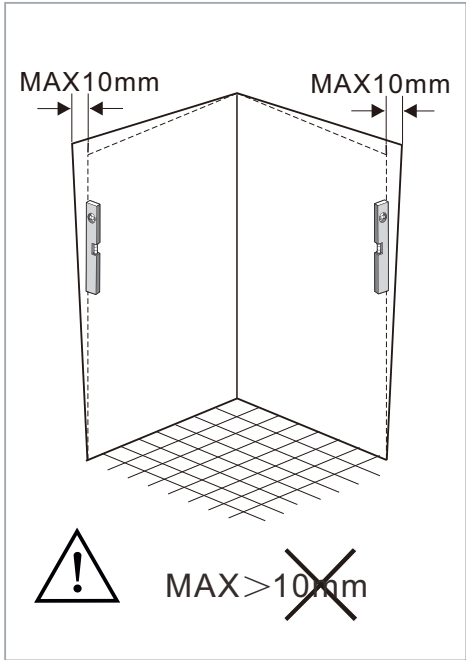
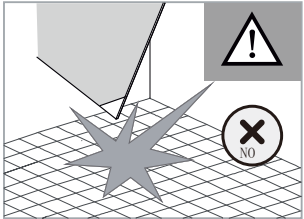
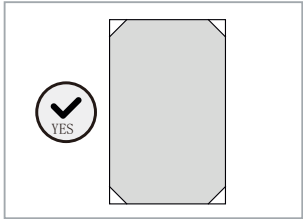
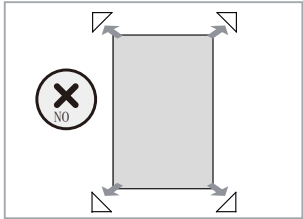
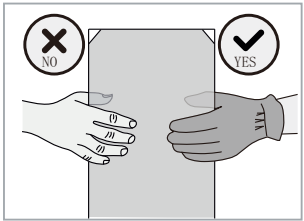
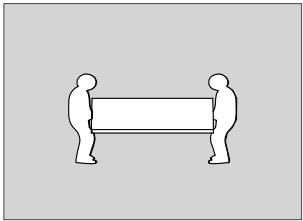
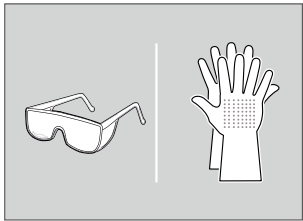
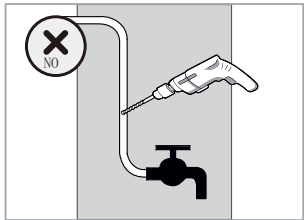
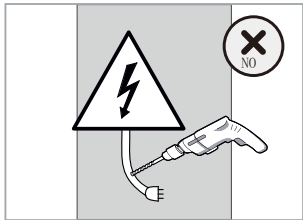
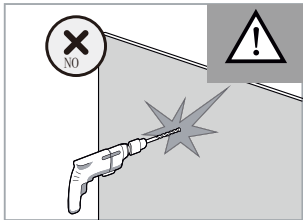

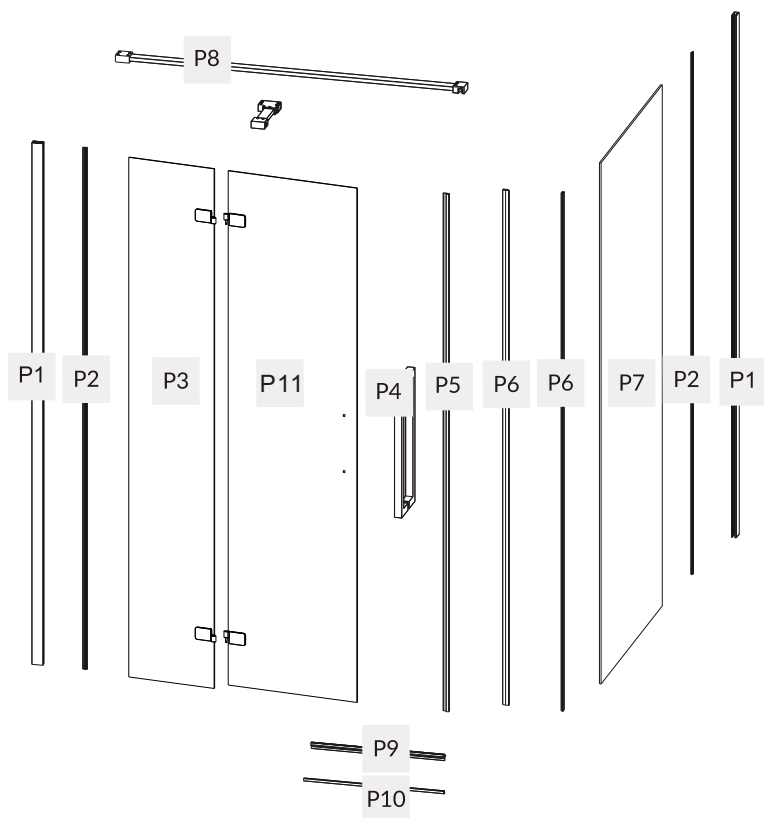

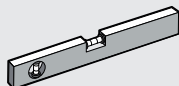
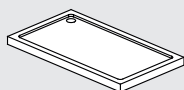
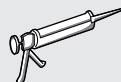
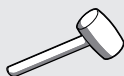
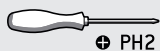
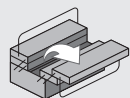
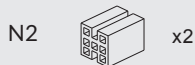
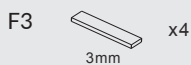
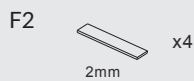
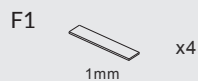
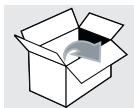

1.

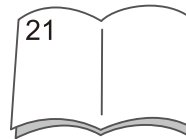
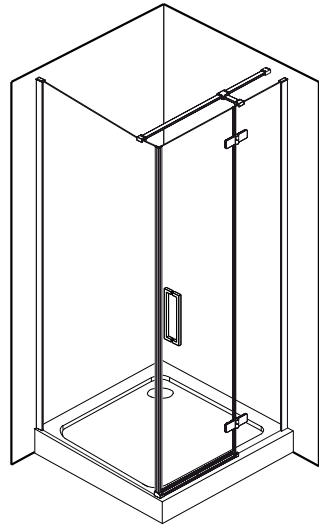
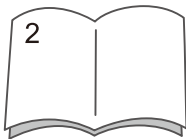
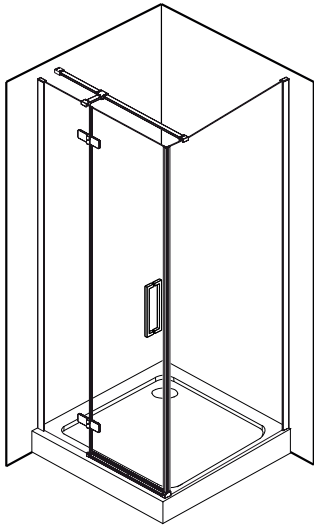

2.

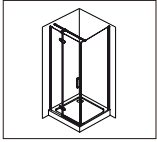

SIZE	X (mm)	Y (mm)
900X900X1950	885	895

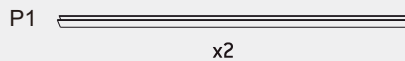
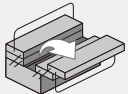
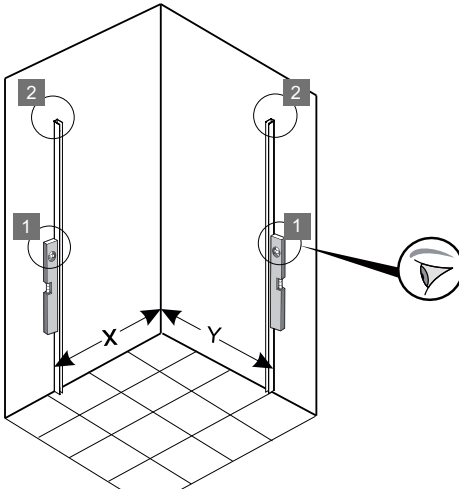
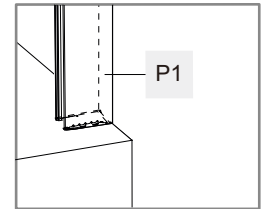
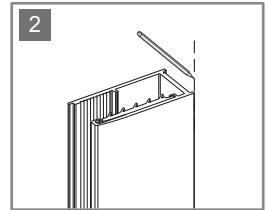
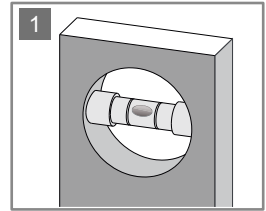
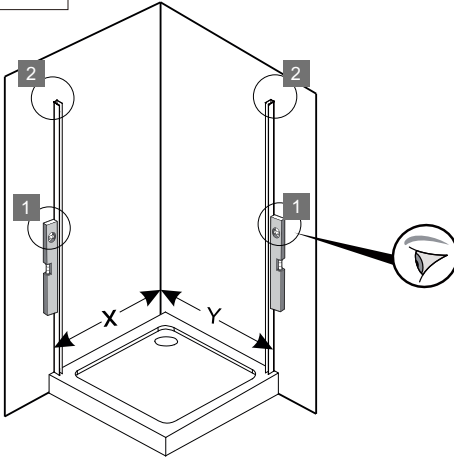

3.

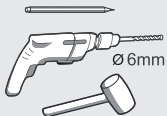
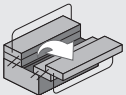
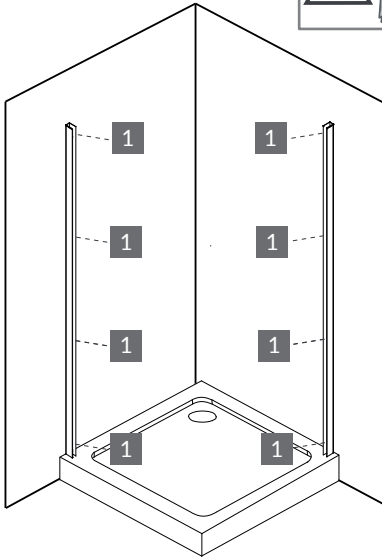
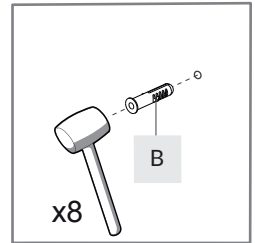
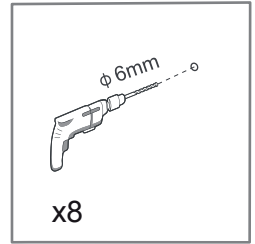
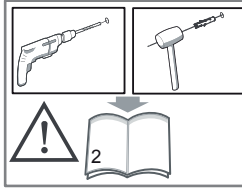
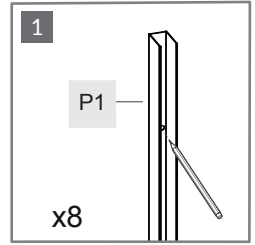
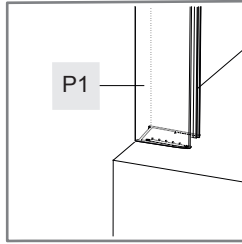
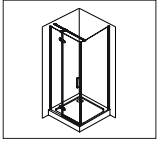

B



x8



4.

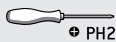
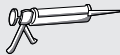
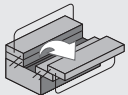
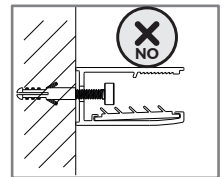
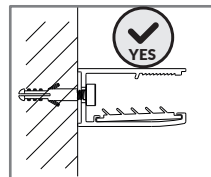
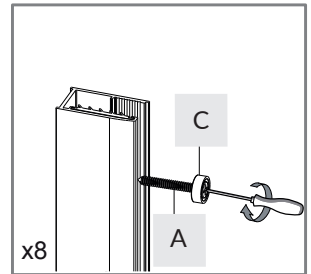
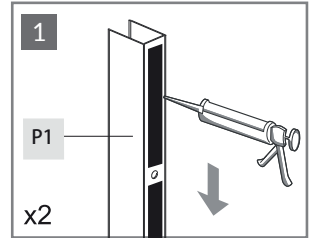
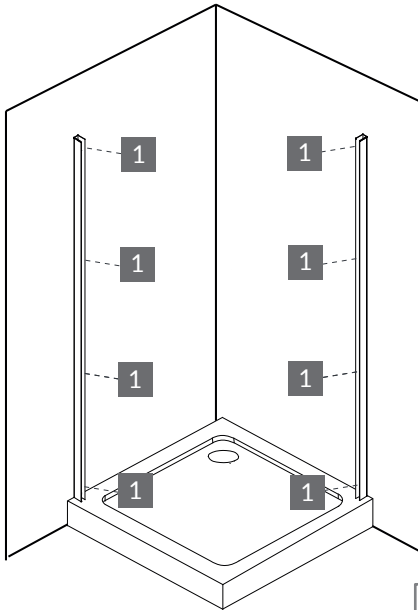
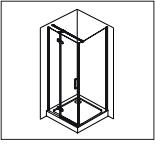

P1



x2

C



x8

A



4x35 x8



5.

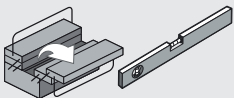
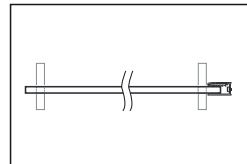
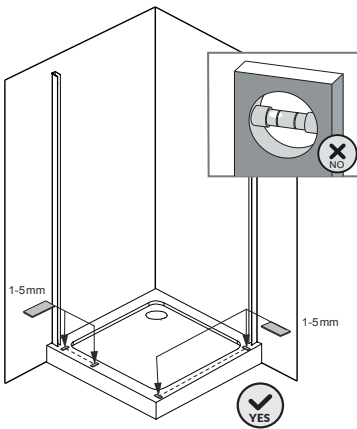
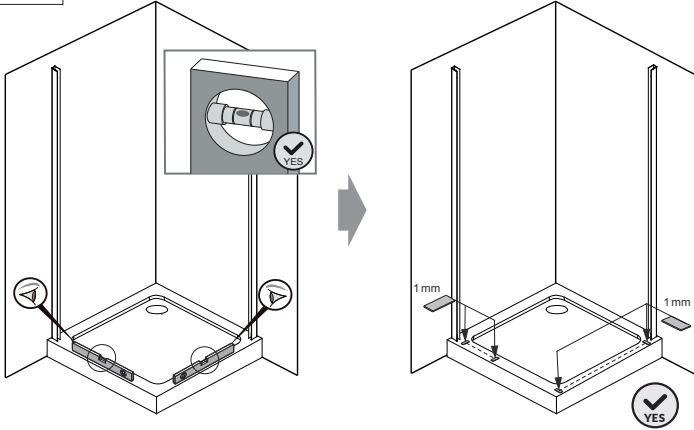
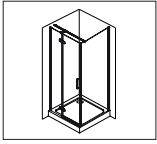

F1



x4

F2



x4

F3



x4



6.

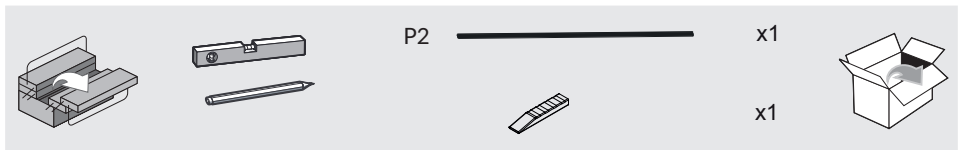
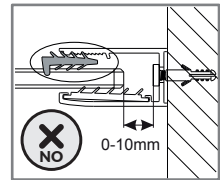
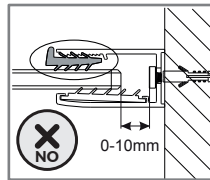
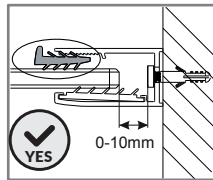
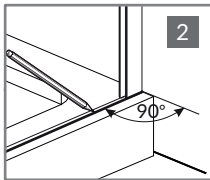
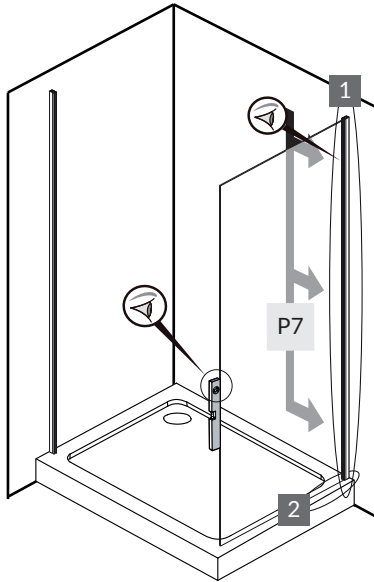
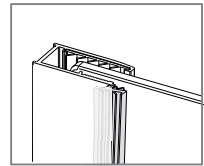
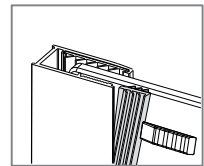
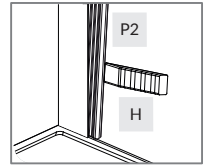
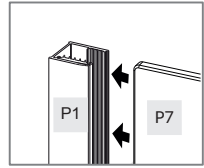
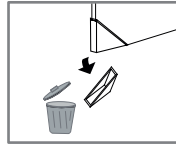
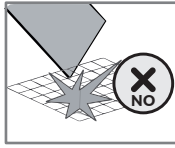
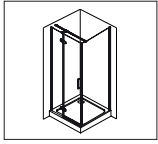

7.

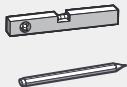
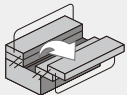
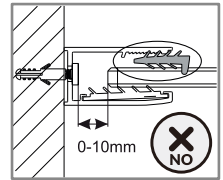
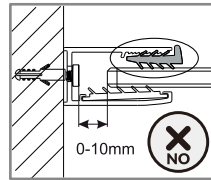
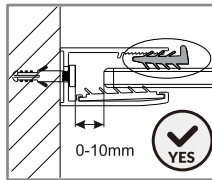
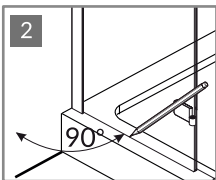
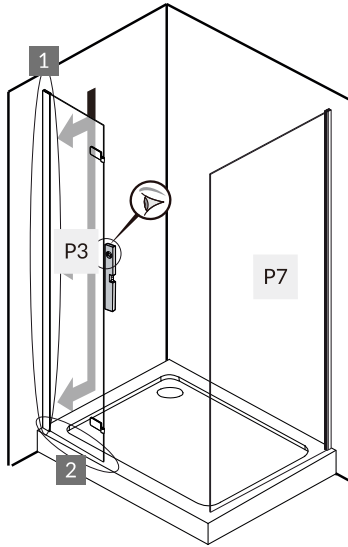
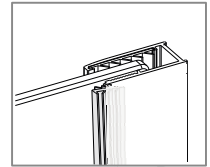
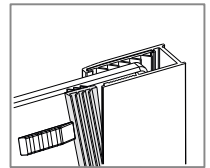
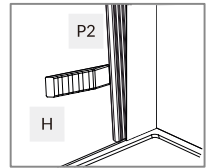
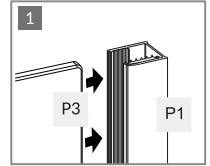
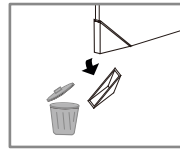
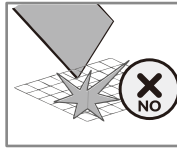
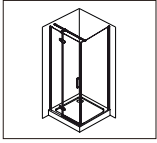

P2 ————— x1

H ————— x1



8.

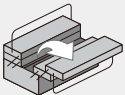
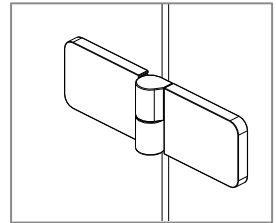
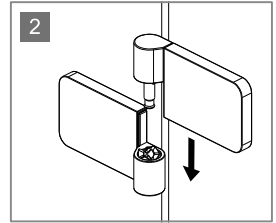
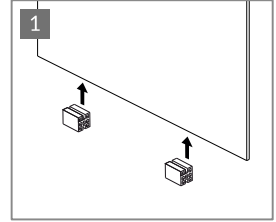
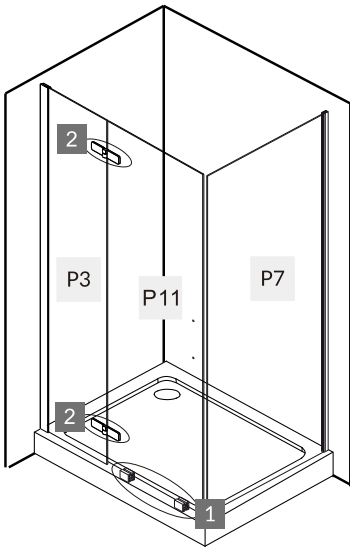
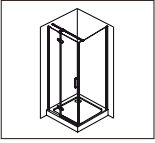

P11

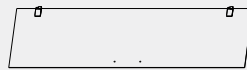

x1

N2



x2



9.

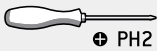
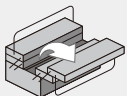
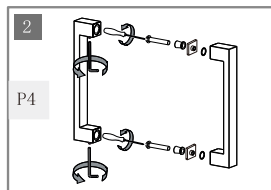
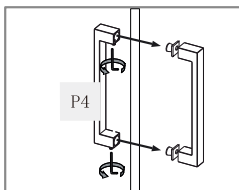
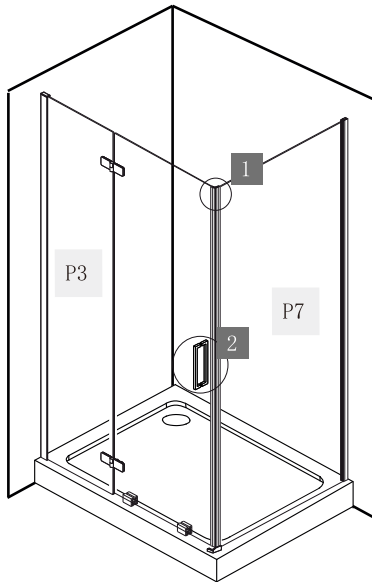
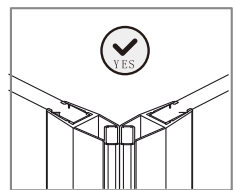
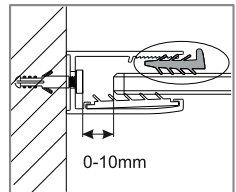
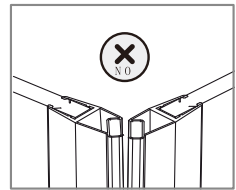
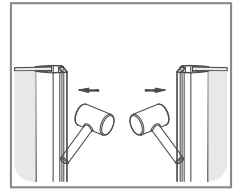
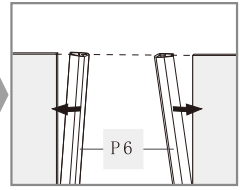
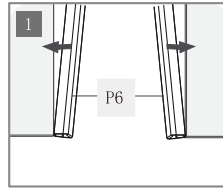
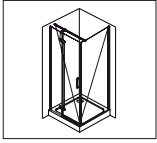

P6

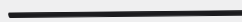

x2

P4



x1



10.

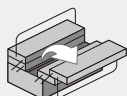
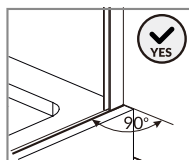
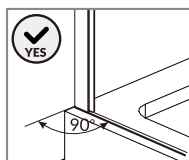
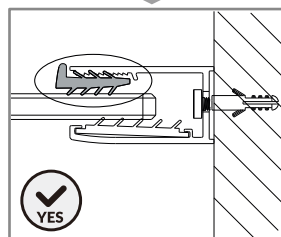
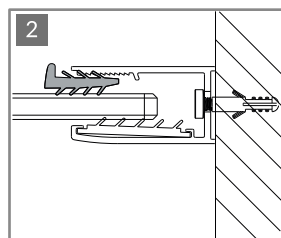
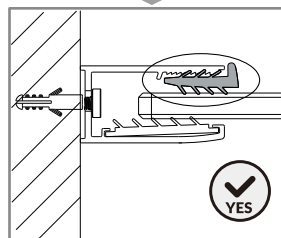
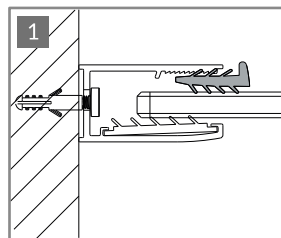
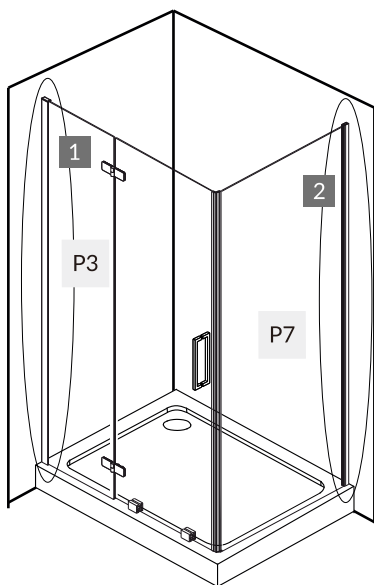
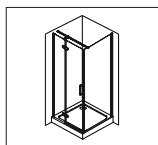

H



x1



11.

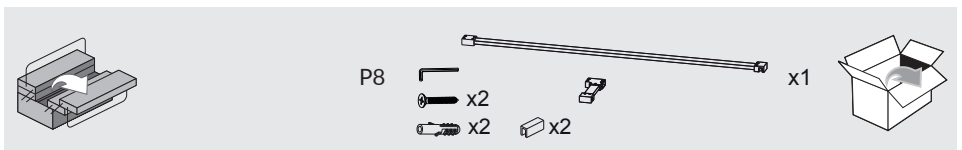
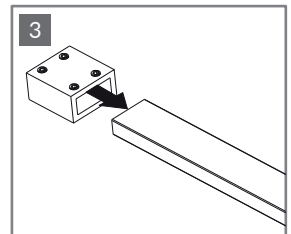
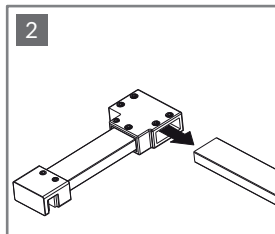
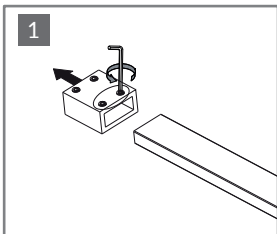
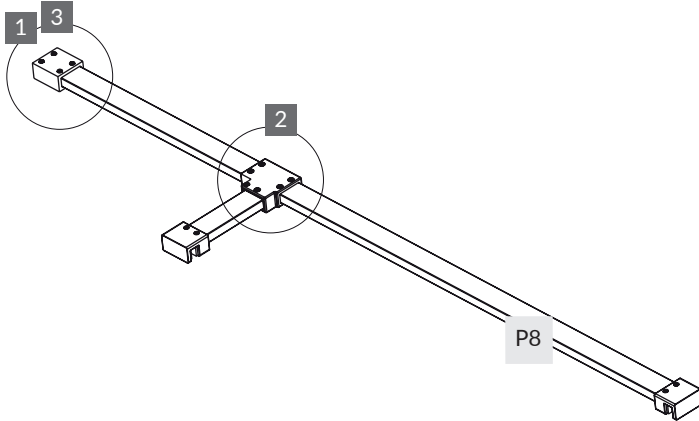
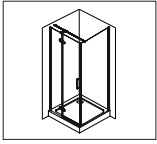

12.

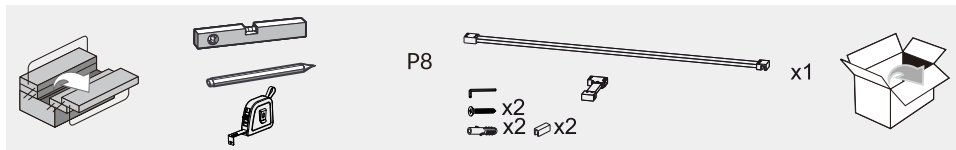
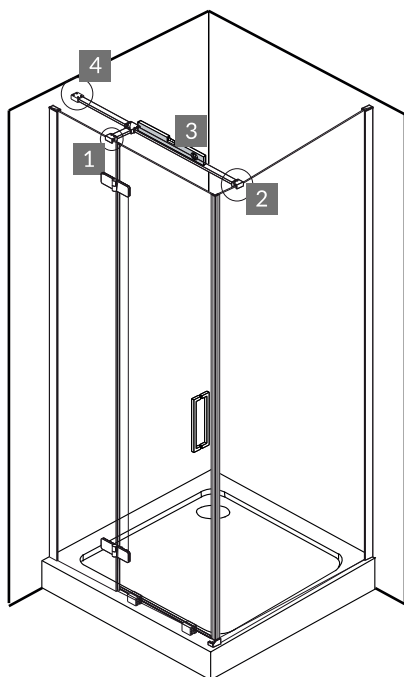
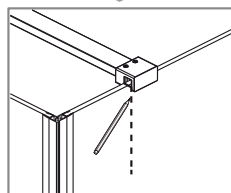
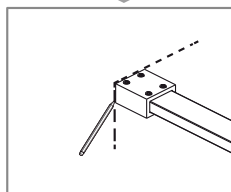
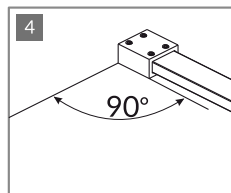
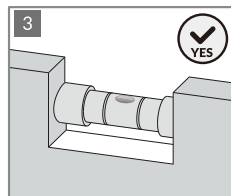
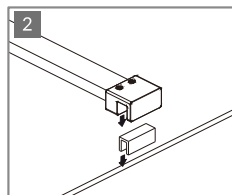
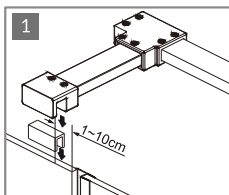
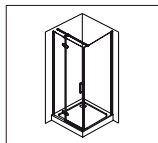

13.

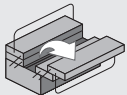
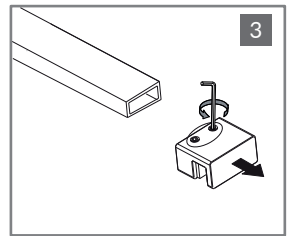
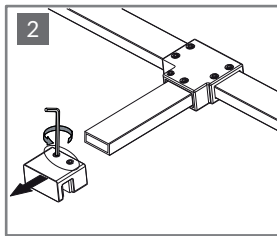
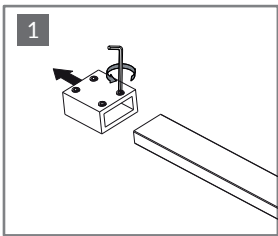
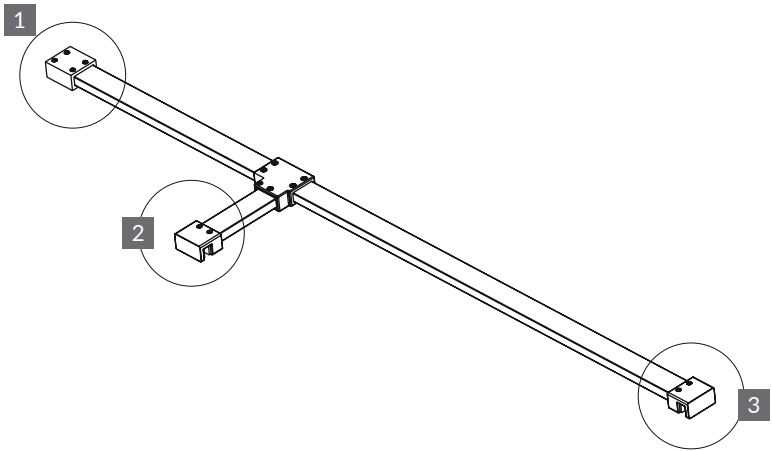
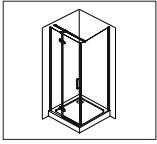

P8



x1

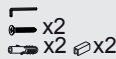

x2

x2 x2



14.

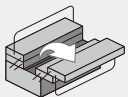
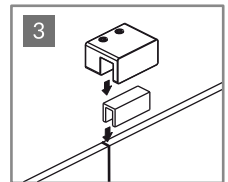
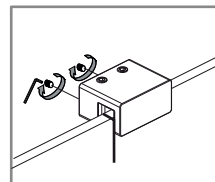
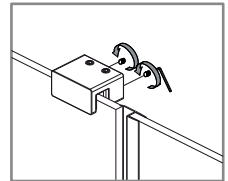
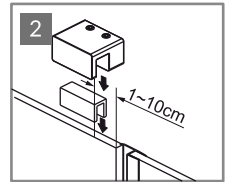
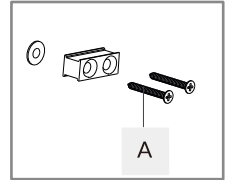
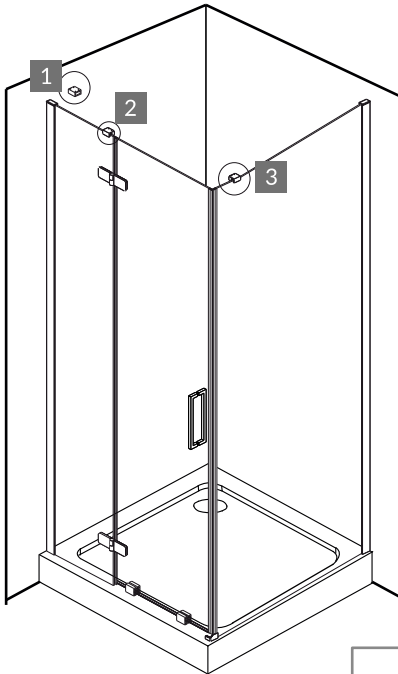
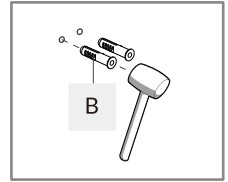
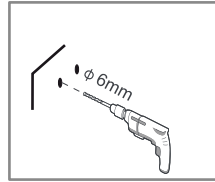
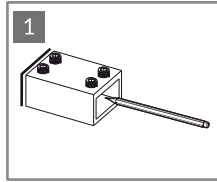
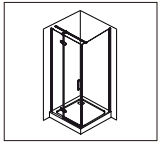

A  4x35 x2

B  x2



15.

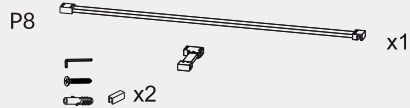
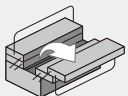
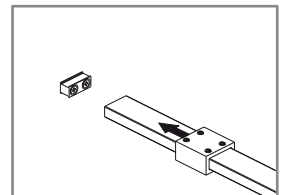
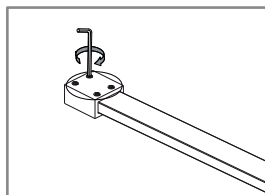
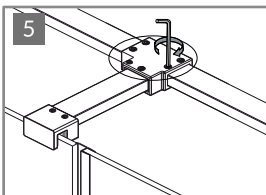
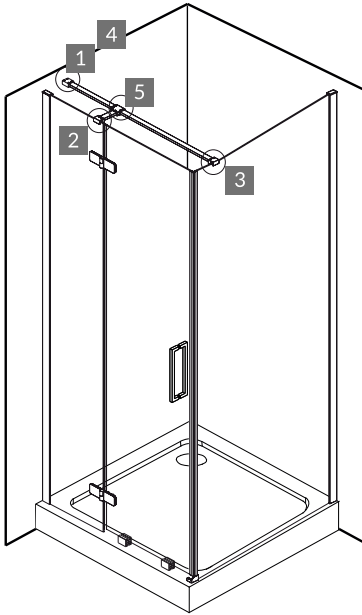
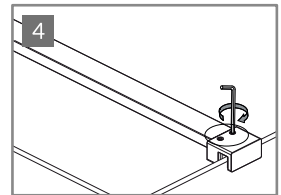
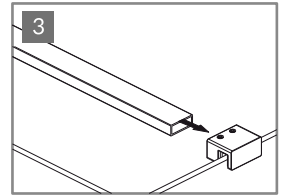
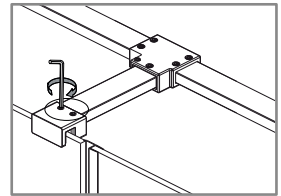
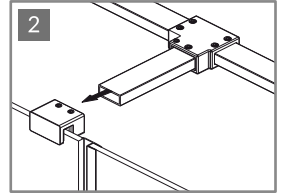
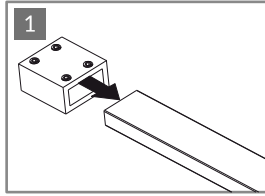
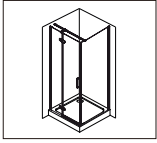

16.

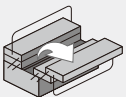
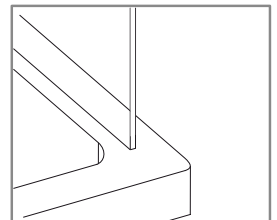
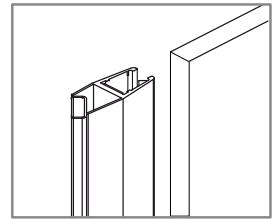
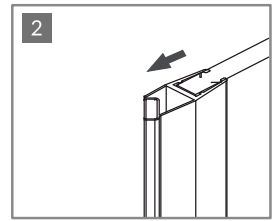
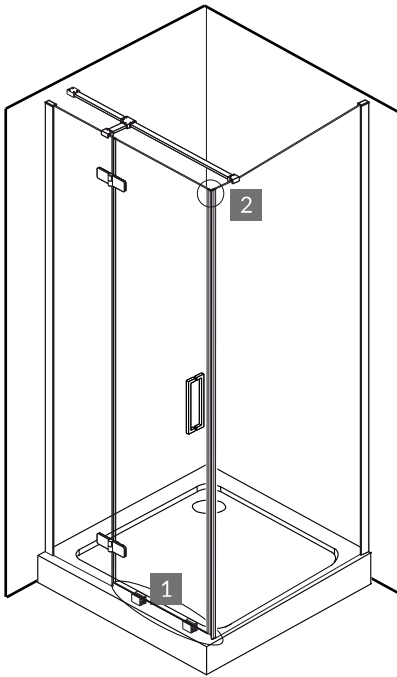
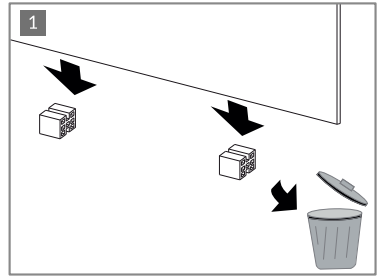
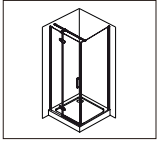

N2



x2



17.

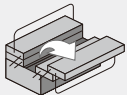
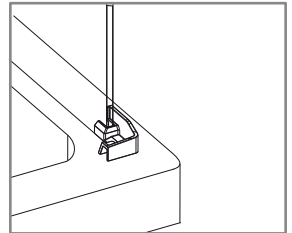
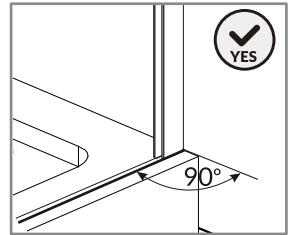
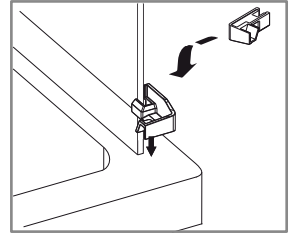
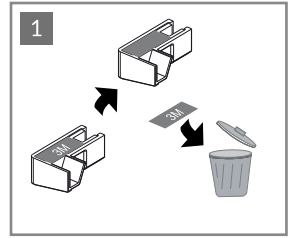
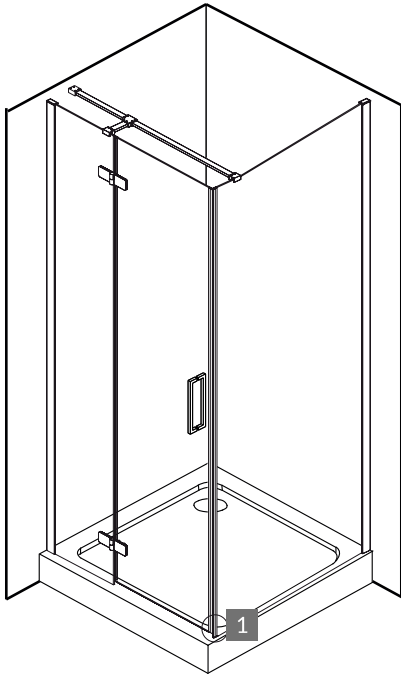
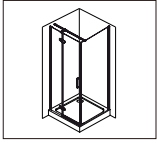

L1



x1



18.

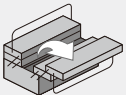
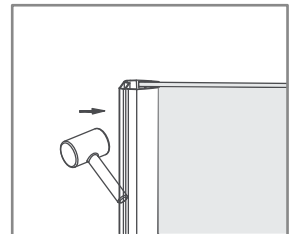
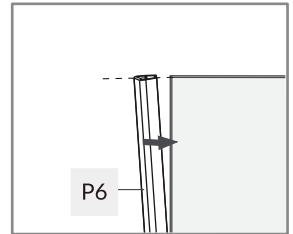
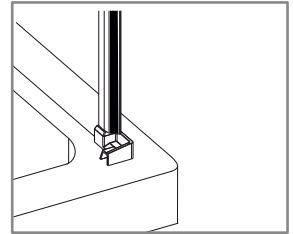
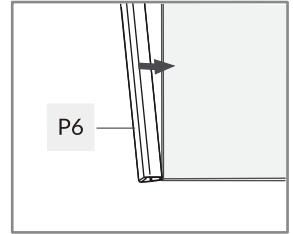
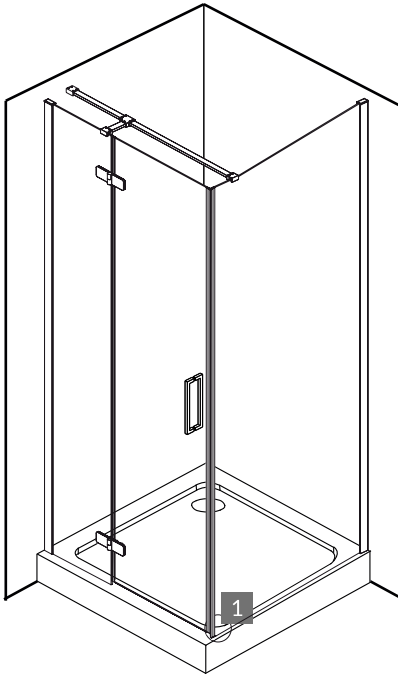
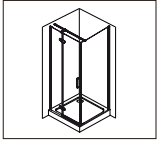

P6



x1



19.

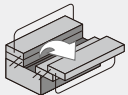
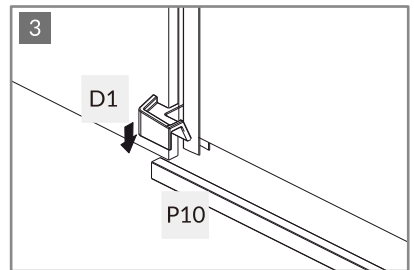
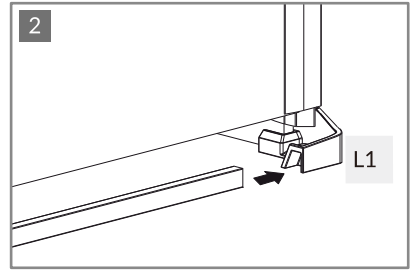
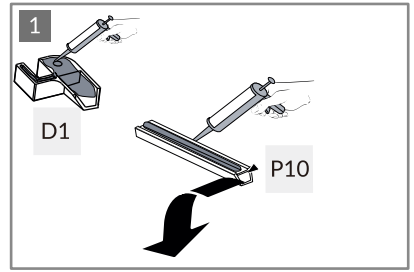
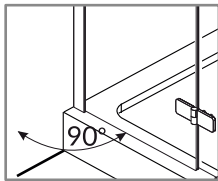
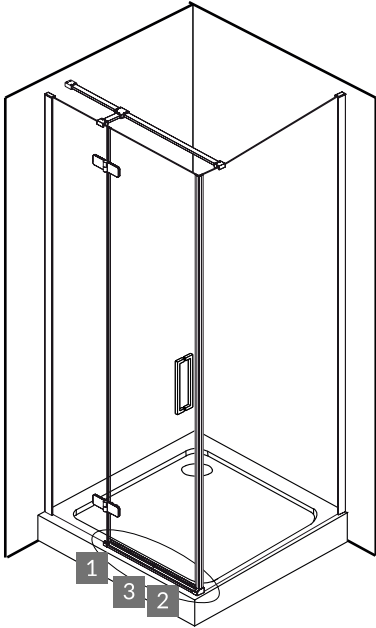
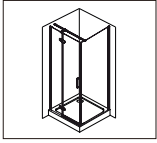

P10



x1

D1



x1



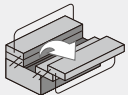
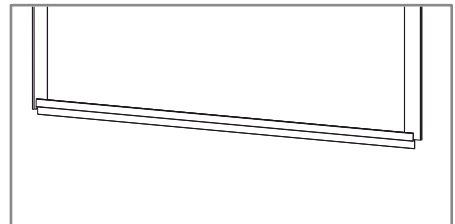
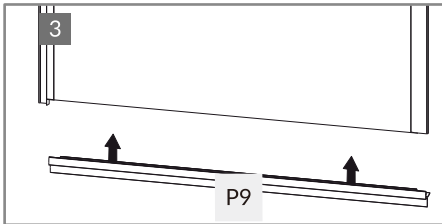
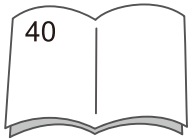
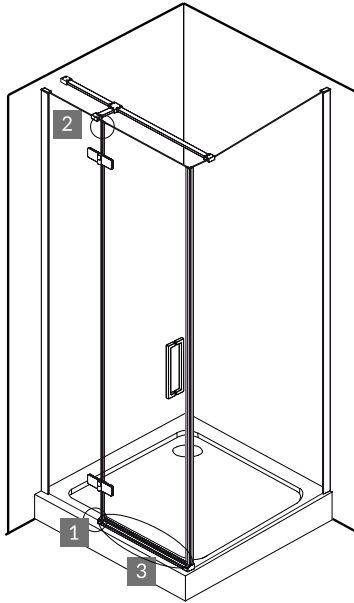
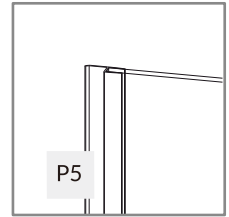
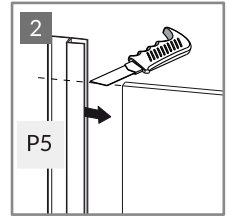
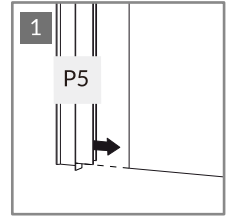
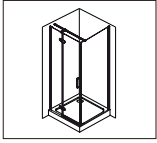

P5  x1

P9  x1



21.

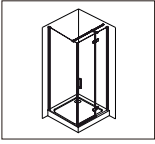

SIZE	X (mm)	Y (mm)
900X900X1950	885	895

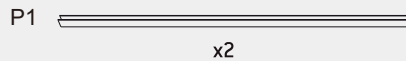
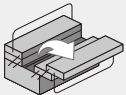
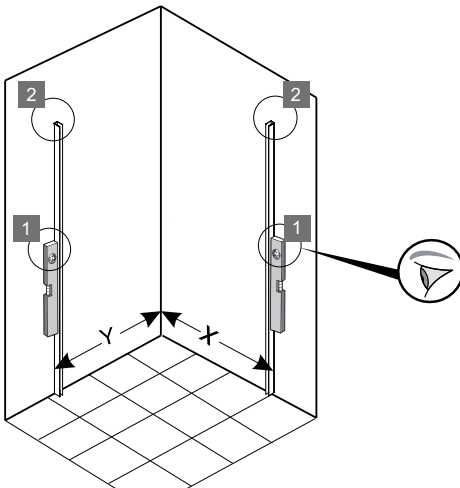
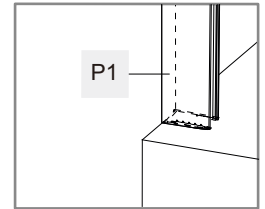
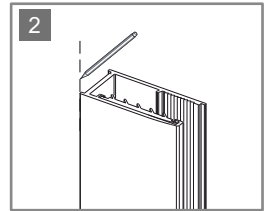
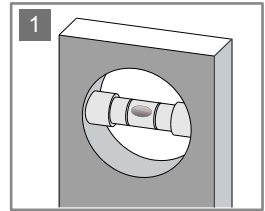
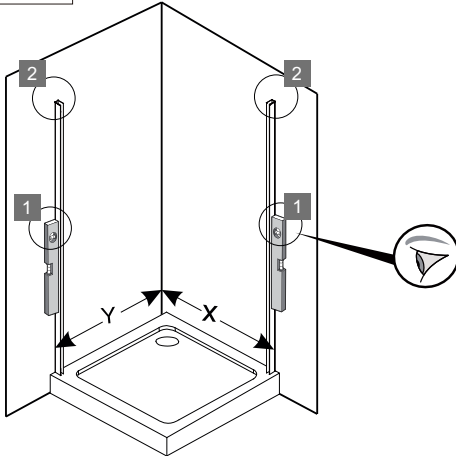

22.

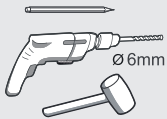
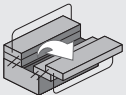
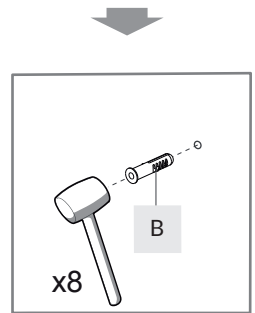
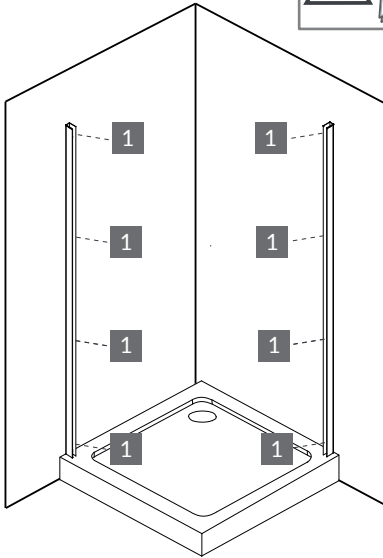
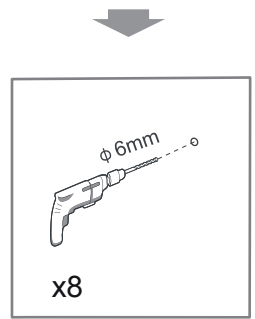
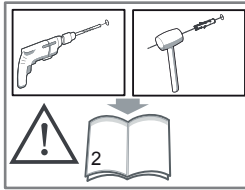
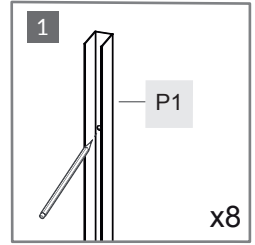
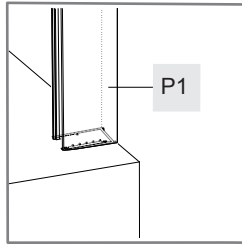
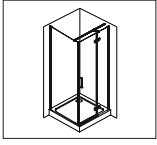

B



x8



23.

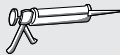
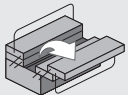
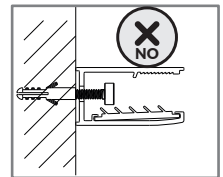
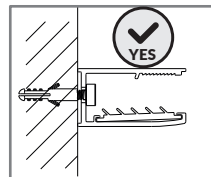
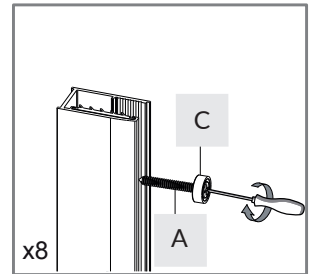
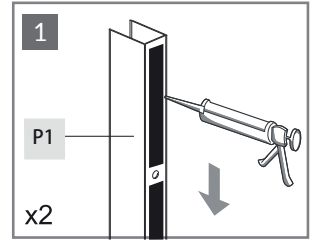
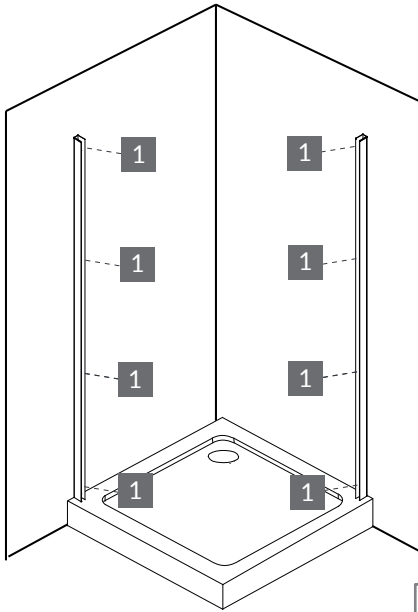
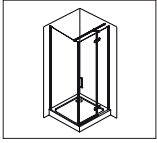

P1



x2



PH2

C



x8

A



4x35

x8



24.

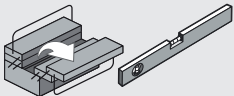
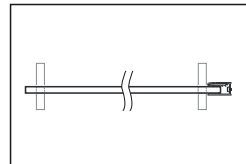
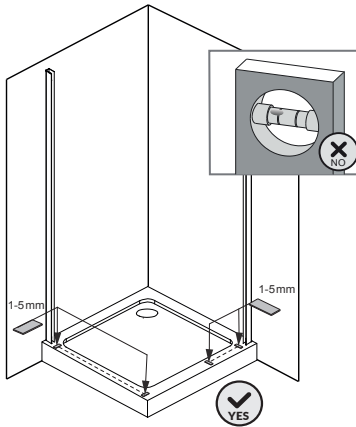
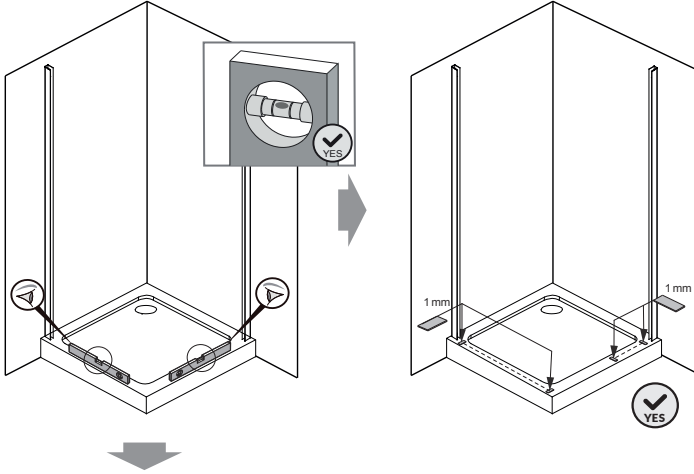
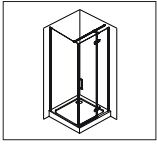

F1



x4

F2



x4

F3



x4



25.

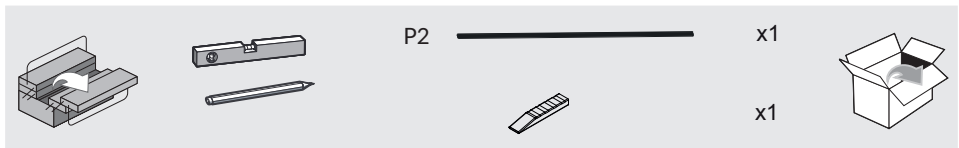
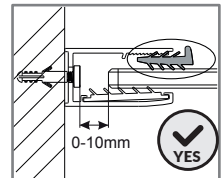
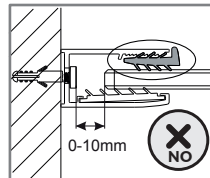
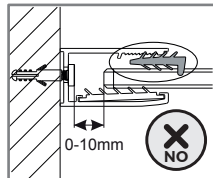
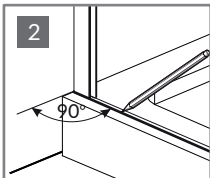
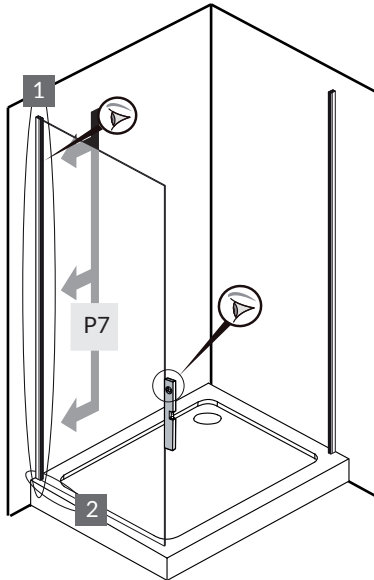
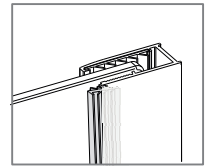
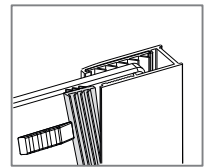
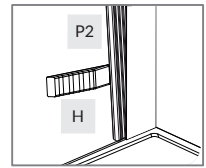
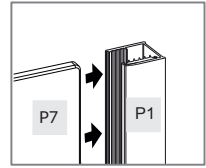
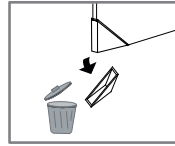
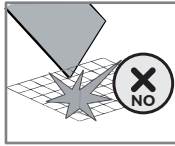
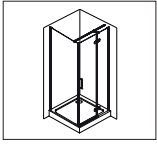

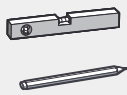
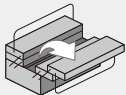
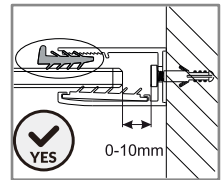
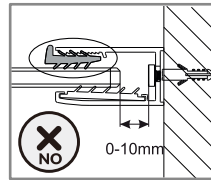
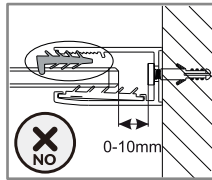
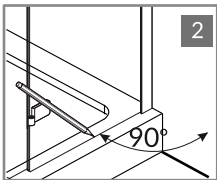
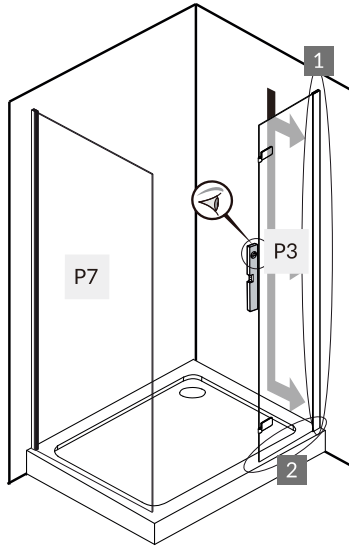
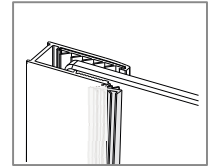
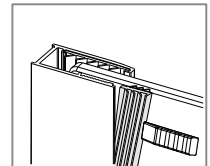
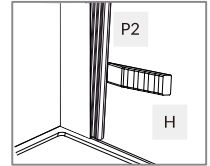
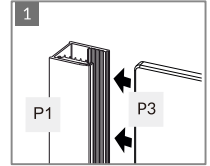
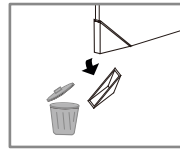
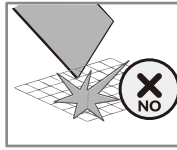
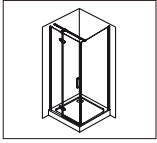

P2 ————— x1

H ————— x1



27.

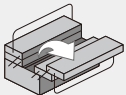
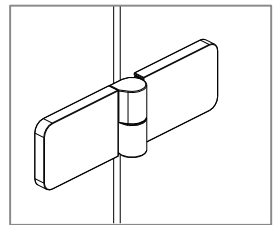
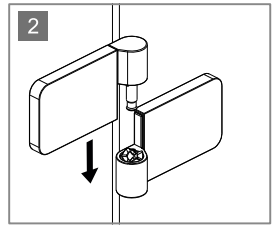
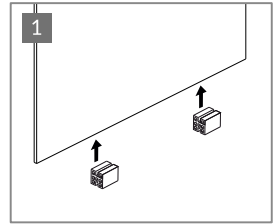
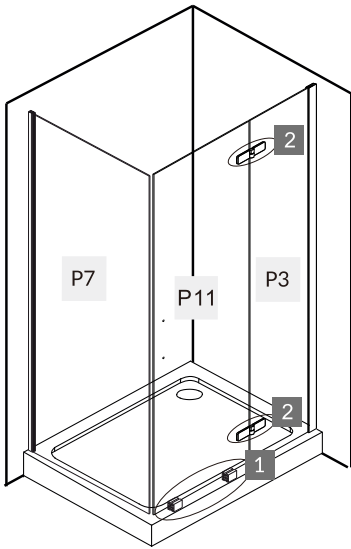
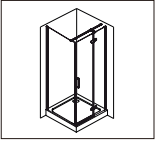

P11

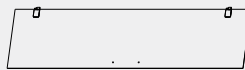

x1

N2



x2



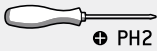
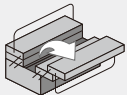
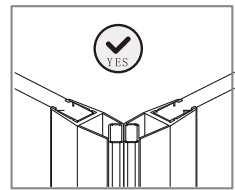
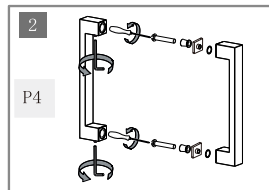
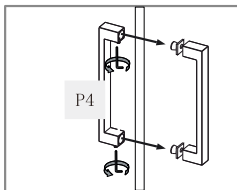
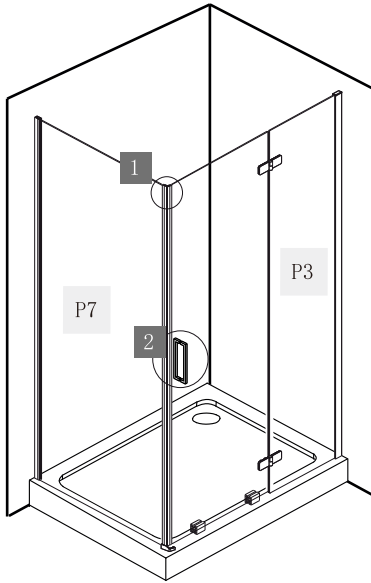
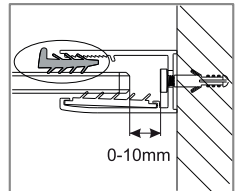
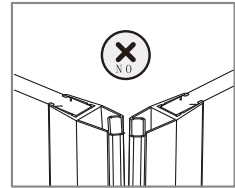
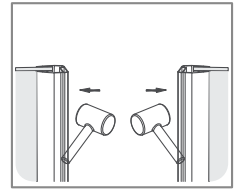
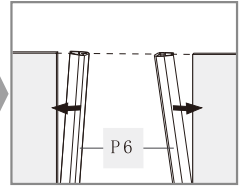
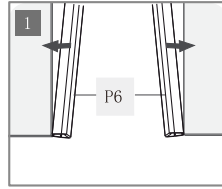
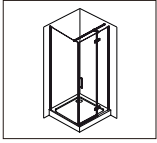

⊕ PH2

P6

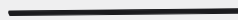

x2

P4



x1



29.

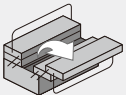
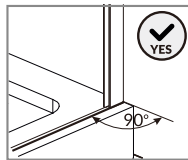
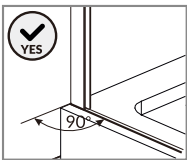
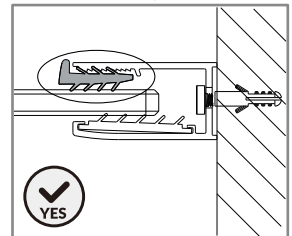
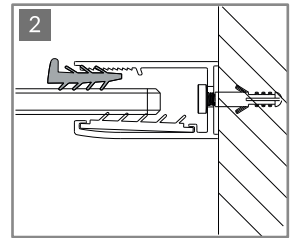
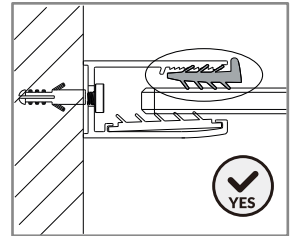
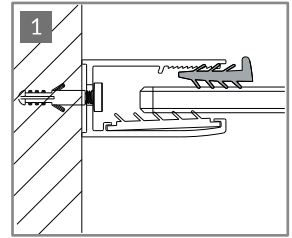
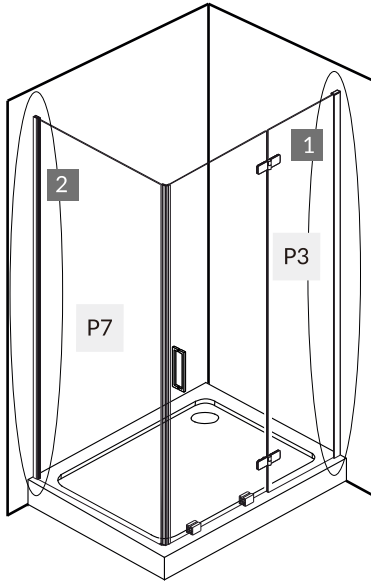
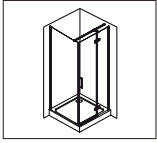

H







x1

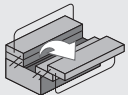
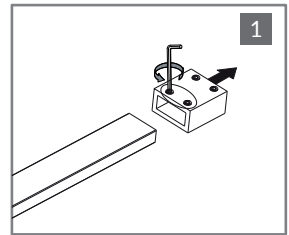
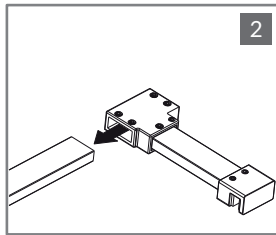
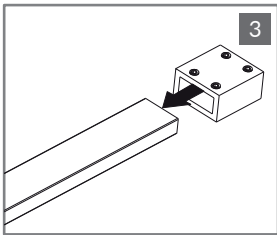
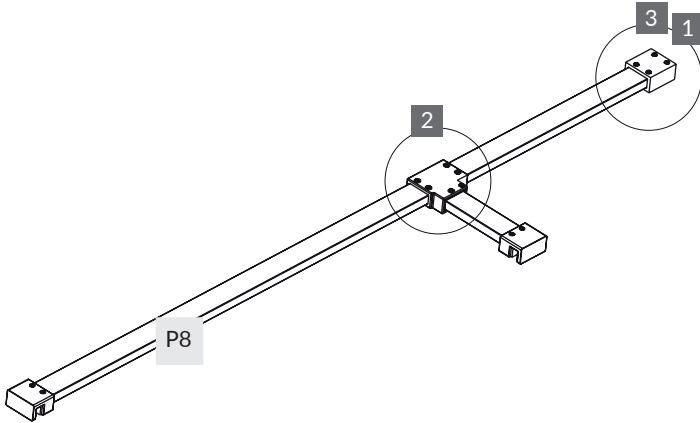
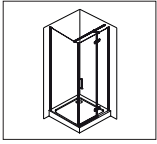

30.



- P8
-  x2
-  x2
-  x2
-  x2
-  x1



31.

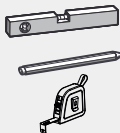
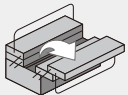
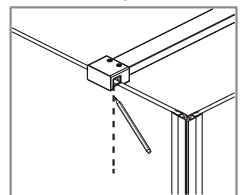
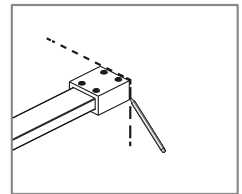
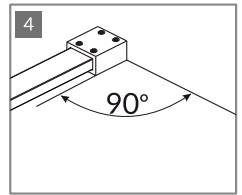
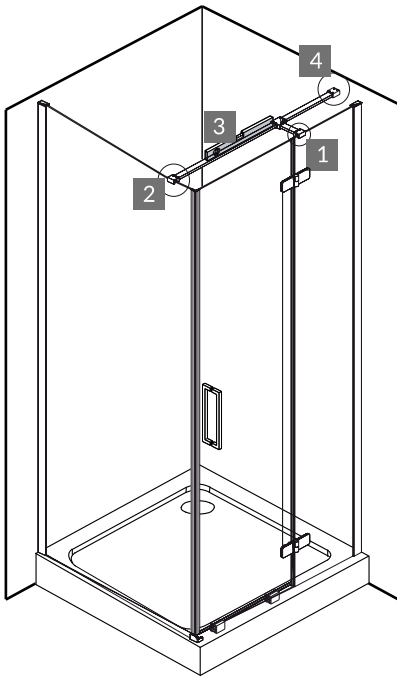
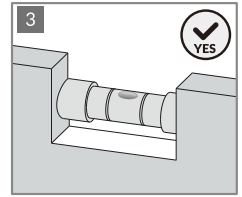
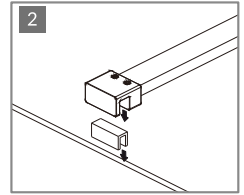
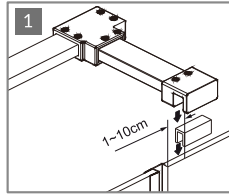
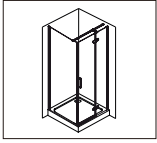

P8



x1

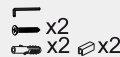

x2

x2 x2



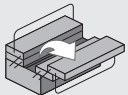
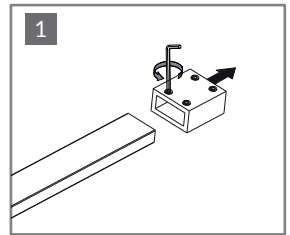
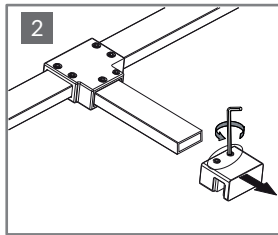
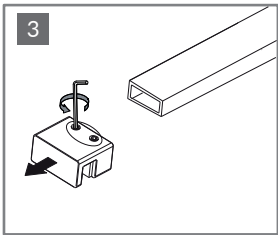
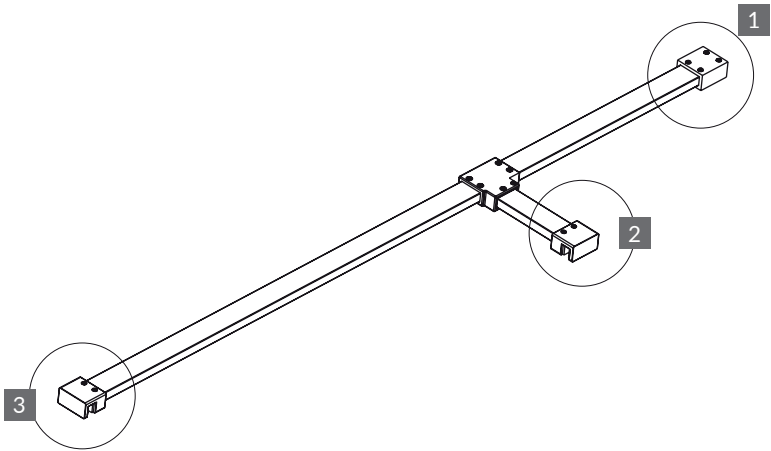
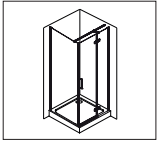

P8



x1

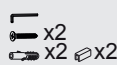

33.

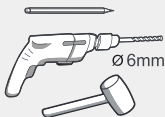
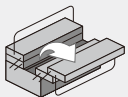
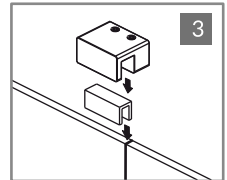
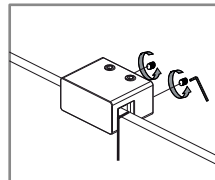
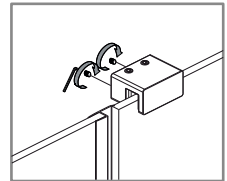
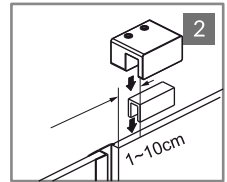
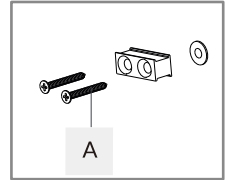
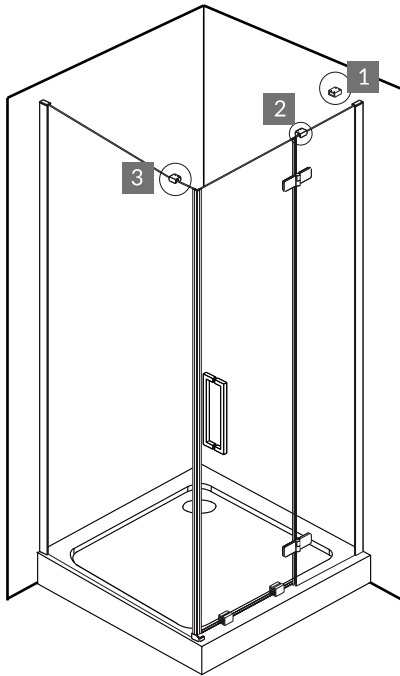
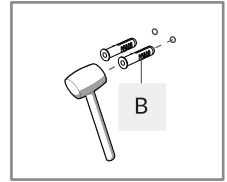
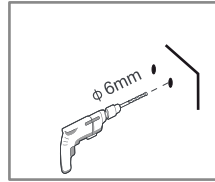
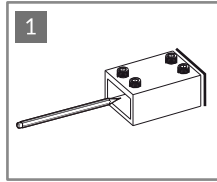
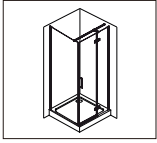

A  x2
4x35

B  x2



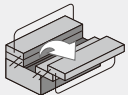
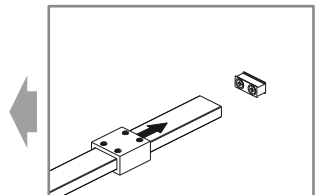
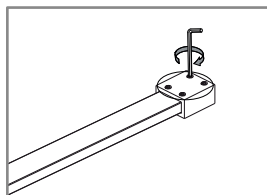
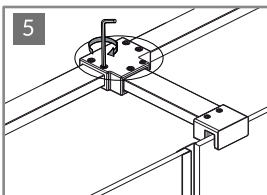
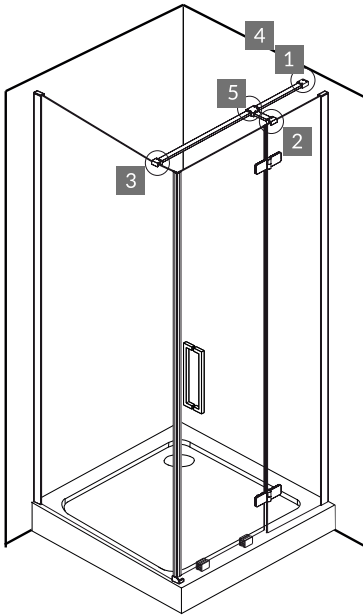
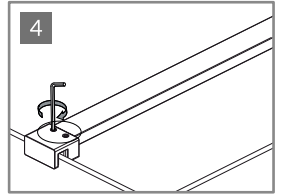
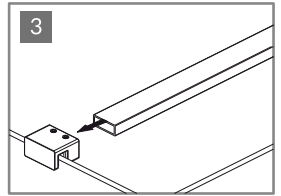
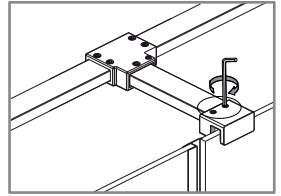
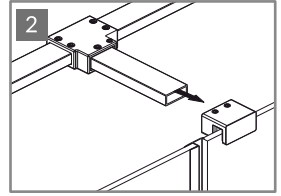
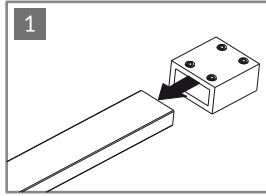
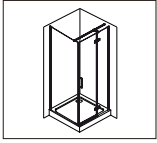

P8



x1



x2



35.

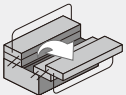
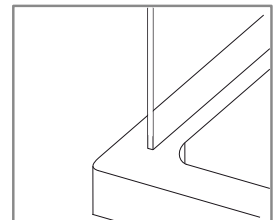
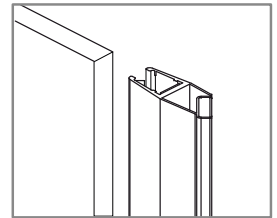
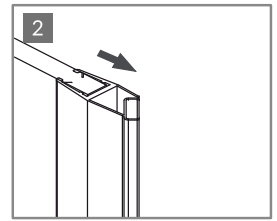
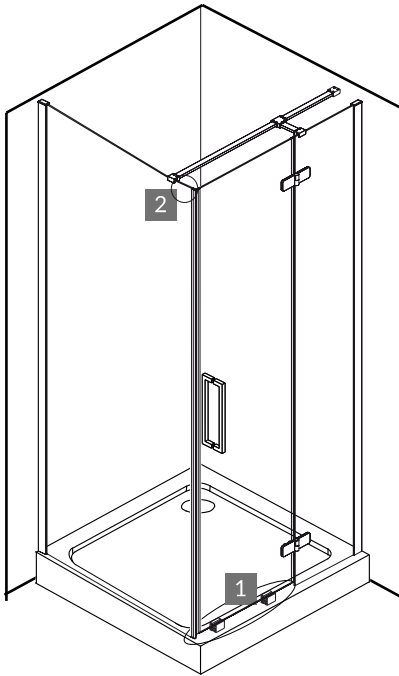
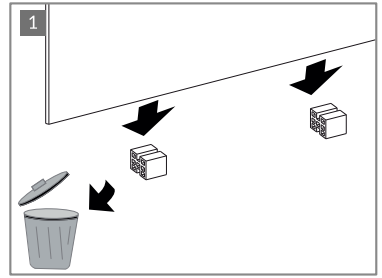
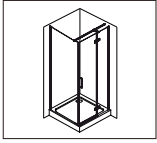

N2



x2



36.

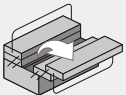
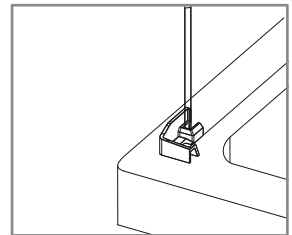
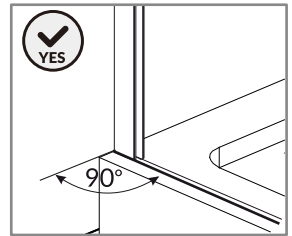
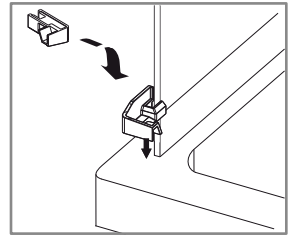
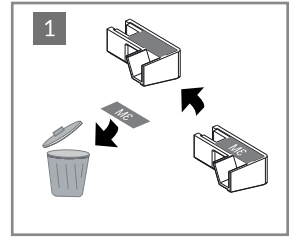
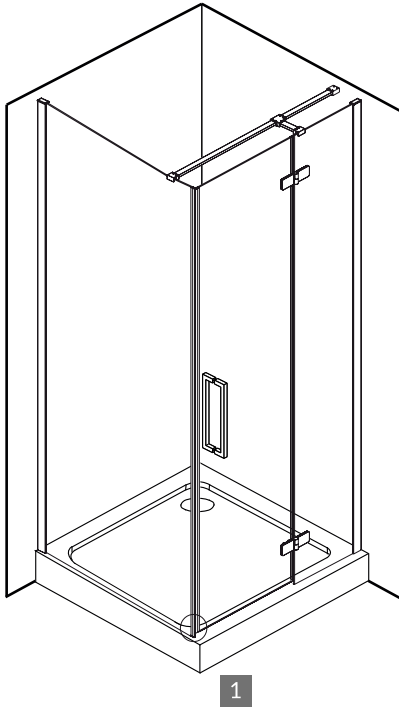
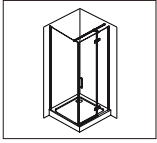

L2



x1



37.

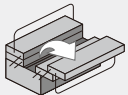
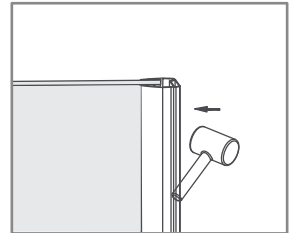
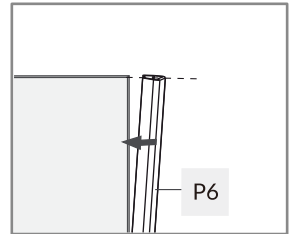
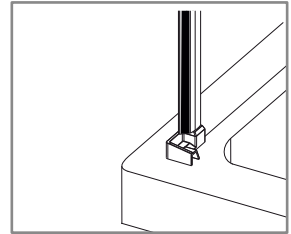
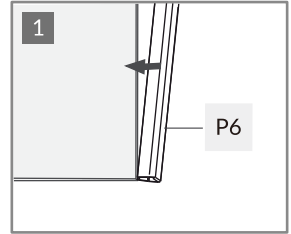
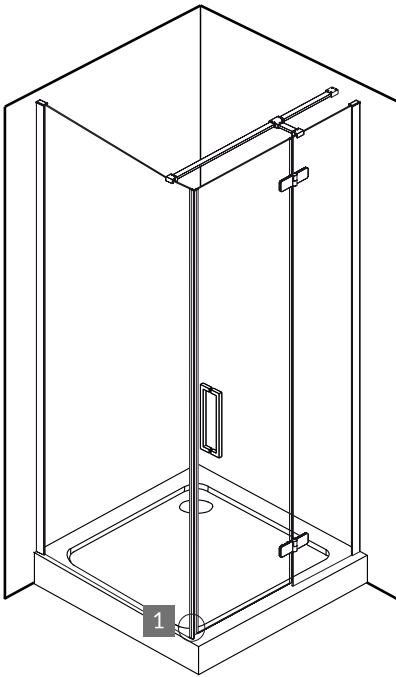
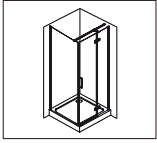

P6



x1



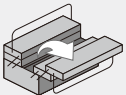
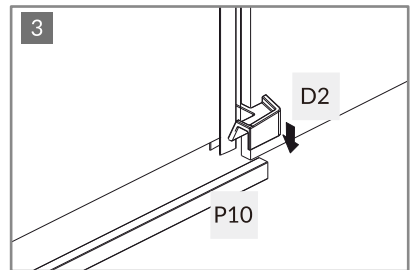
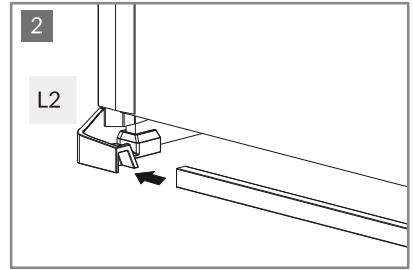
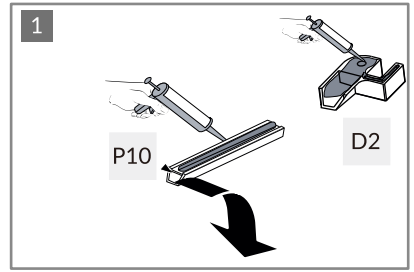
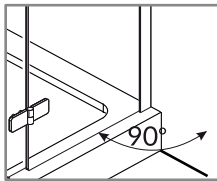
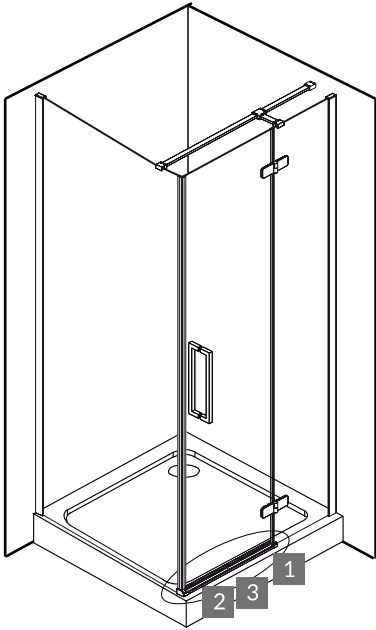
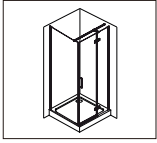

P10



x1

D2



x1



39.

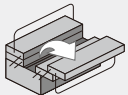
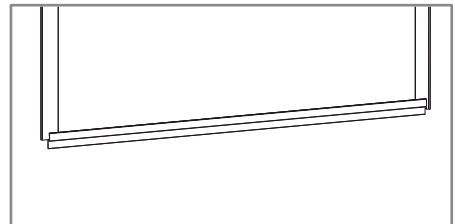
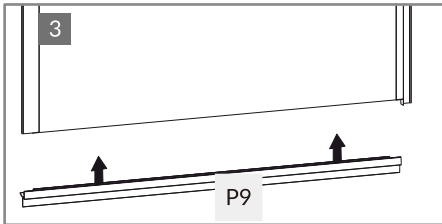
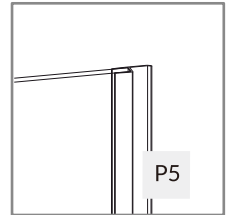
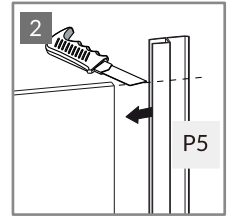
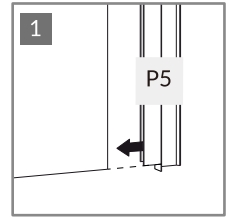
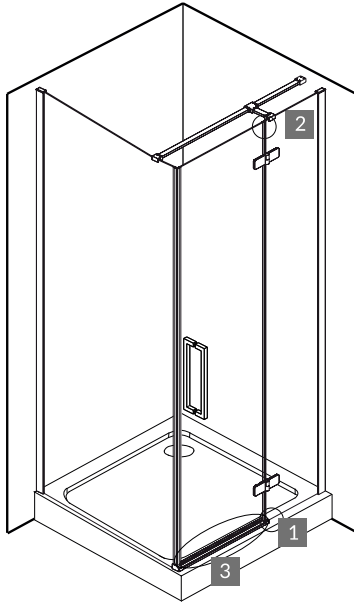
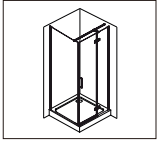

P5  x1

P9  x1



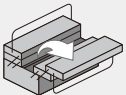
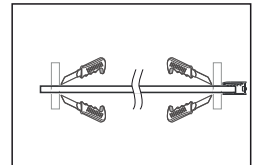
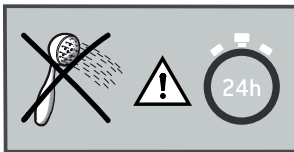
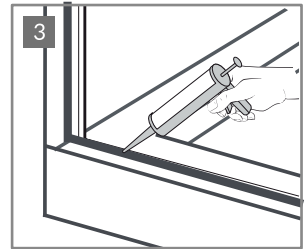
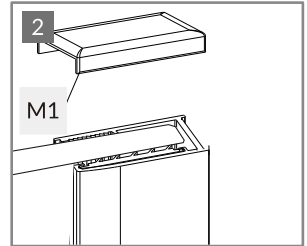
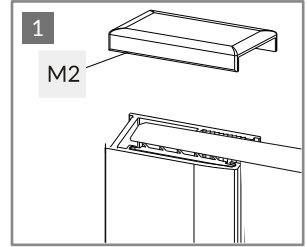
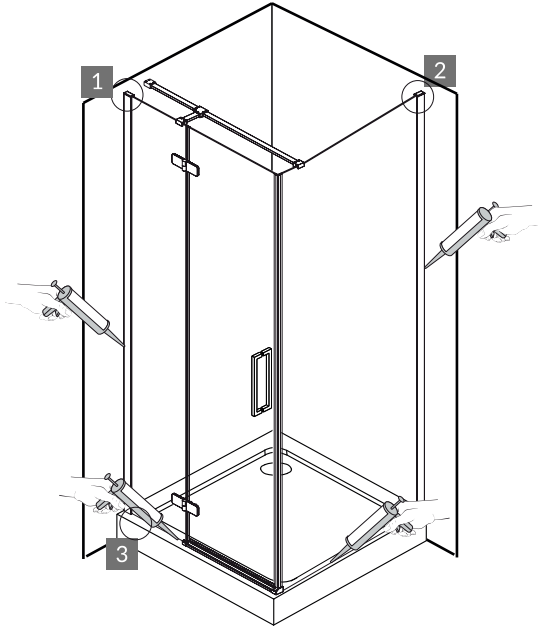
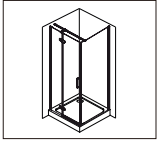

M1 

x1

M2 

x1





6.5<PH<7.5

