

PL: Powierzchnia montażowa musi być czysta równa, stabilna, bez spękań. Miejsce montażu brodzika oraz układu odpływowego należy odpowiednio uszczelnić, np. folią w płynie. Zapobiega to zalaniu niższej kondygnacji w przypadku rozszczelnienia odpływu.

EN: The mounting surface must be clean, even, stable, without cracks. The place of installation of the shower tray and drainage system should be properly sealed, e.g. with a liquid foil. This prevents flooding of the lower floor in the event of leakage of the drain.

DE: Die Montagefläche muss sauber, eben, stabil, ohne Risse sein. Der Einbaustelle der Duschwanne und des Ablaufsystems sollte gut abgedichtet werden, z.B. mit einer Flüssigfolie. Dadurch wird ein Überfluten des unteren Geschosses bei Undichtigkeit des Abflaus verhindert.

FR: La surface de montage doit être propre, plane, stable, sans fissures. Le lieu d'installation du receveur de douche et du système d'évacuation doit être correctement scellé, par exemple avec un film liquide. Cela évite l'inondation de l'étage inférieur en cas de fuite du drain.

CZ: Montážní povrch musí být čistý, rovný, stabilní, bez trhlin. Místo instalace sprchové vaničky a drenážního systému by mělo být řádně utěsněno, např. tekutou fólií. Tím se zabrání zaplavení spodního patra v případě netěsnosti odtoku.

SK: Montážny povrch musí byť čistý, rovný, stabilný, bez trhlín. Miesto inštalácie sprchovej vaničky a drenážneho systému by malo byť riadne utesnené, napríklad tekutou fóliou. Tým sa zabráni zaplaveniu spodného poschodia v prípade netesnosti odtoku.

HU: A rögzítési felületnek tisztának, egyenletesnek, stabilnak, repedésmentesnek kell lennie. A zuhanytálca és a vízelvezető rendszer felszerelési helyét megfelelően le kell zárni, például folyékony fóliával. Ez megakadályozza az alsó szint elárasztását lefolyó szivárgása esetén.

RO: Suprafața de montare trebuie să fie curată, uniformă, stabilă, fără fisuri. Locul de instalare a căii de duș și a sistemului de scurgere trebuie să fie sigilat corespunzător, de exemplu cu o folie lichidă. Acest lucru previne inundarea etajului inferior în cazul scurgerii scurgerii.

RU: Монтажная поверхность должна быть чистой, ровной, устойчивой, без трещин. Место установки душевого поддона и дренажной системы необходимо тщательно закрыть, например, жидкой пленкой. Это предотвращает затопление нижнего этажа в случае протечки слива.

HR: Montažna površina mora biti čista, ravna, stabilna, bez pukotina. Mjesto postavljanja tuš kade i odvodnog sustava potrebno je dobro zatvoriti, npr. tekućom folijom. Time se sprječava poplava donjeg kata u slučaju curenja odvoda.

SR: Montažna površina mora biti čista, ravna, stabilna i bez pukotina. Mesto ugradnje tuš kade i sistema za odvodnjavanje treba propisno zatvoriti, na primer tečnom folijom. Ovo sprečava plavljenje donjeg sprata u slučaju curenja odvoda.

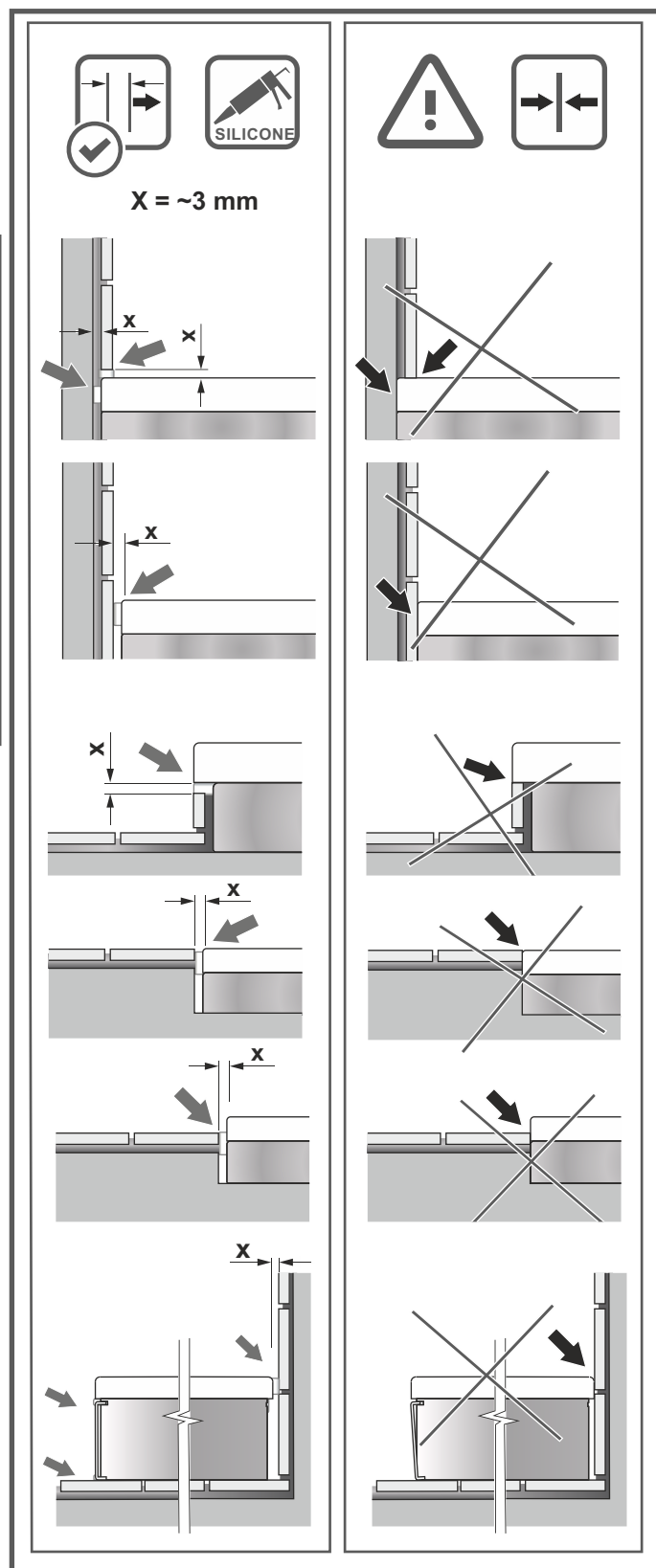

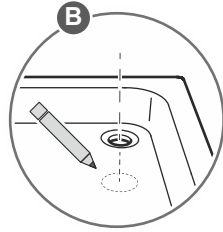
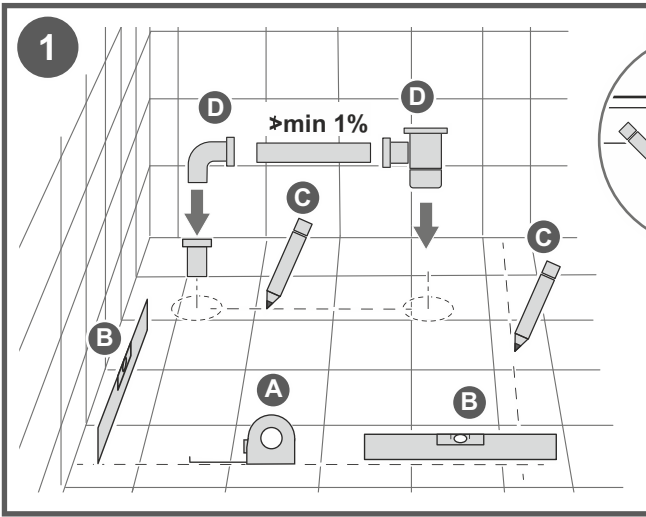

Action icons



2 OPTION! (SELECTED SERIES)

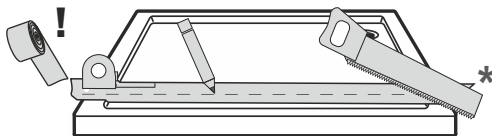

! PL: Zabezpiecz miejsce cięcia taśmą ochronną ! EN: Secure the cutting line with protective tape ! DE: Sichern Sie die Schnittlinie mit einem Schutzband ! FR: Sécurisez la coupe avec un ruban de protection ! CS: Řez zajistěte ochrannou páskou ! SK: Rez zaistite ochrannou páskou ! HU: Rögzítse a vágást védószalaggal ! RO: Asigurați tăietura cu o bandă de protecție ! RU: Закрепите срез защитной лентой ! HR: Osigurajte područje rezanja zaštitnom trakom ! SR: Причврстите област сечења заштитном траком

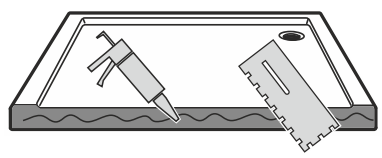

! PL: Zabezpiecz odsłoniętą w wyniku cięcia powierzchnię masą uszczelniającą ! EN: Seal the exposed cut surface with sealing compound ! DE: Versiegeln Sie die mit Schneiden offengelegte Fläche mit einem Dichtungsmittel ! FR: Sécurisez la coupe avec du mastic d'étanchéité ! CS: Zajistěte řez těsnící hmotou ! SK: Zaistite rez tesniacou hmotou ! HU: Rögzítse a vágást tömítőanyaggal ! RO: Asigurați tăietura cu compus de etanșare ! RU: Закрепите срез герметиком ! HR: Osigurajte rez pomoću mase za brtvljenje ! SR: Учврстите рез са заптивним материјалом

OPTION A

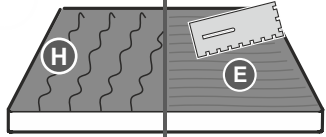

OPTION A

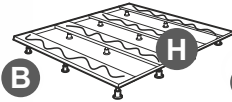

OPTION B

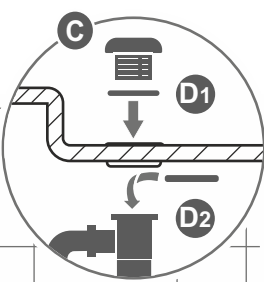
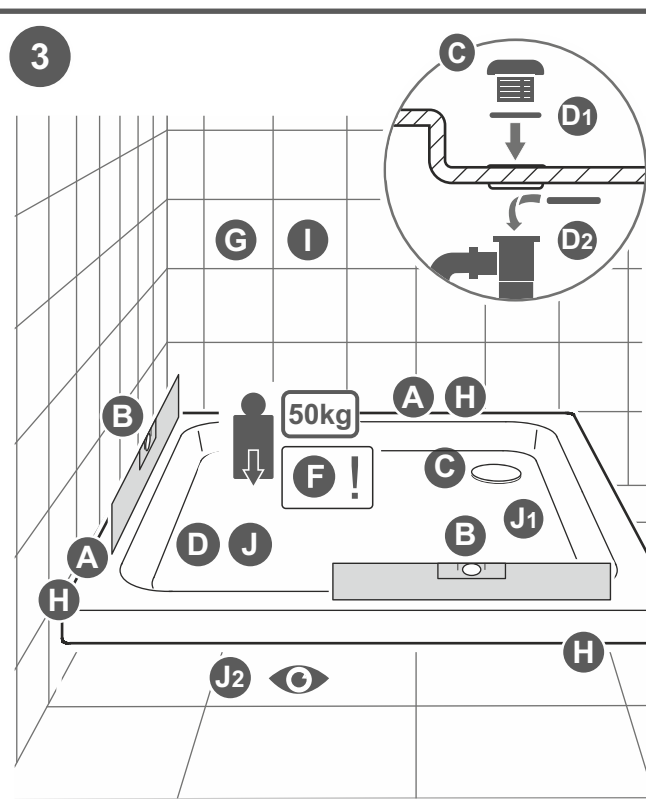
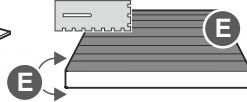

Action icons

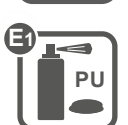

4.1

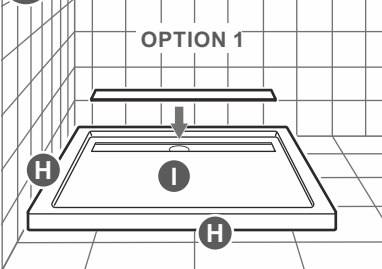

4.2

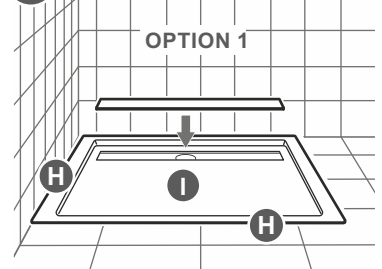

4.3

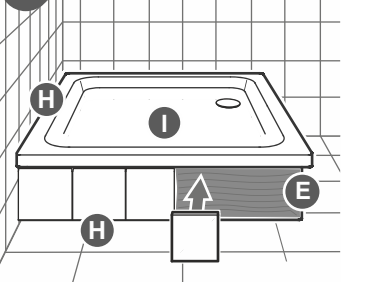

4.4

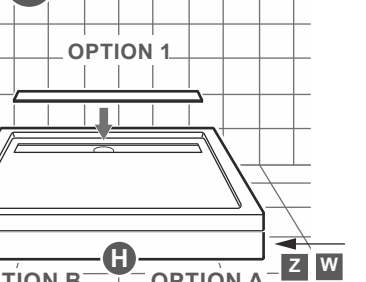

4.4

