

# TYP 35

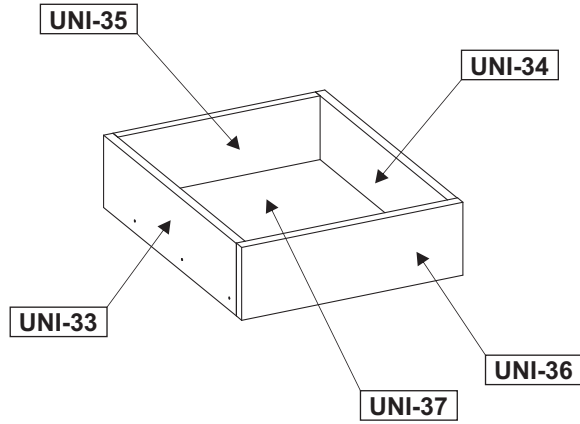

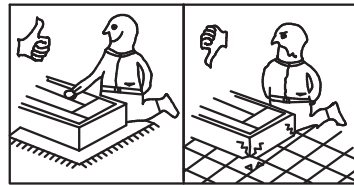

UNI-33	3000394/37	450x120x16	1x	1/1
UNI-34	3000393/36	450x120x16	1x	1/1
UNI-35	3000398/79	343x119x16	1x	1/1
UNI-36	7020084	375x121x18	1x	1/1
UNI-37	3000400/385	353x447x3	1x	1/1

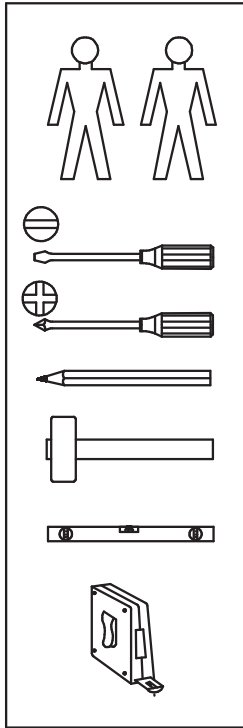
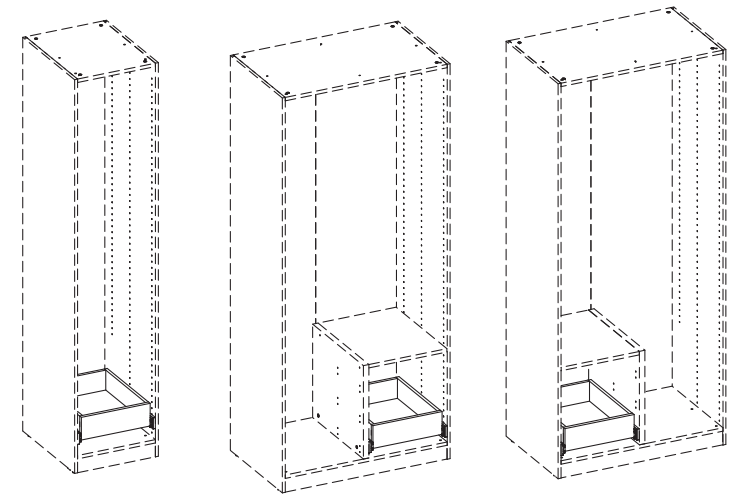

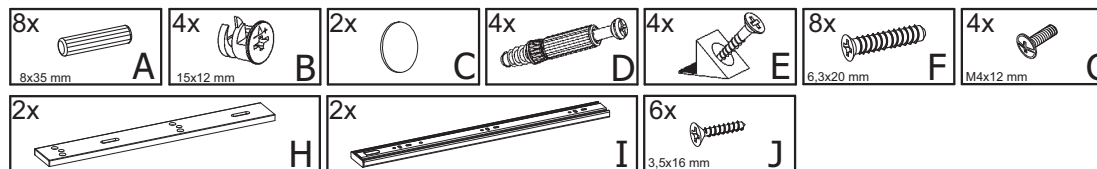
C 1/1



# TYP 35

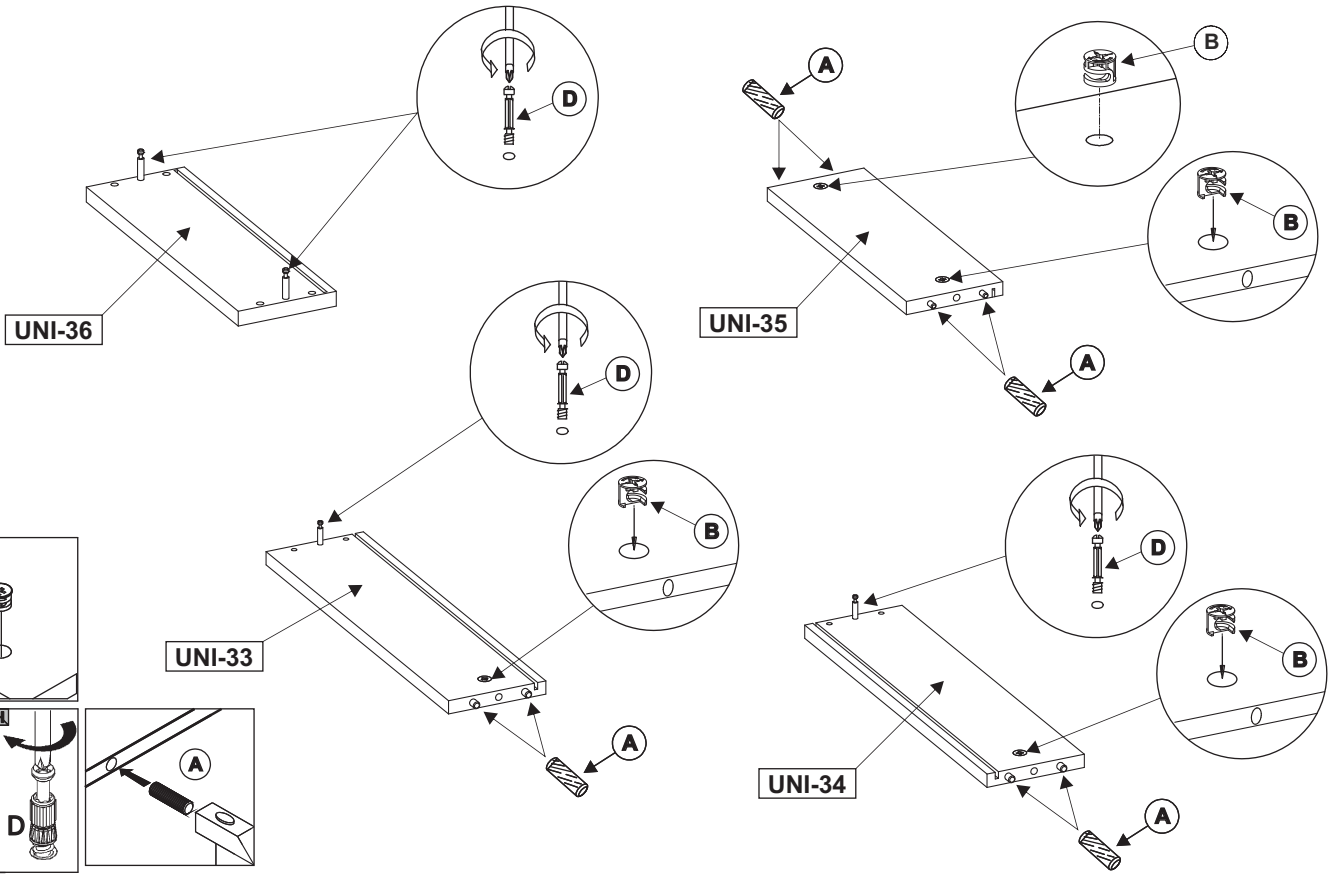
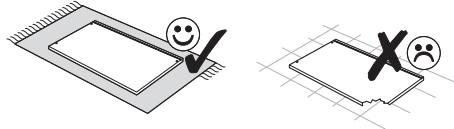

- 8x  A  
8x35 mm
- 4x  B  
15x12 mm
- 4x  D

# 1

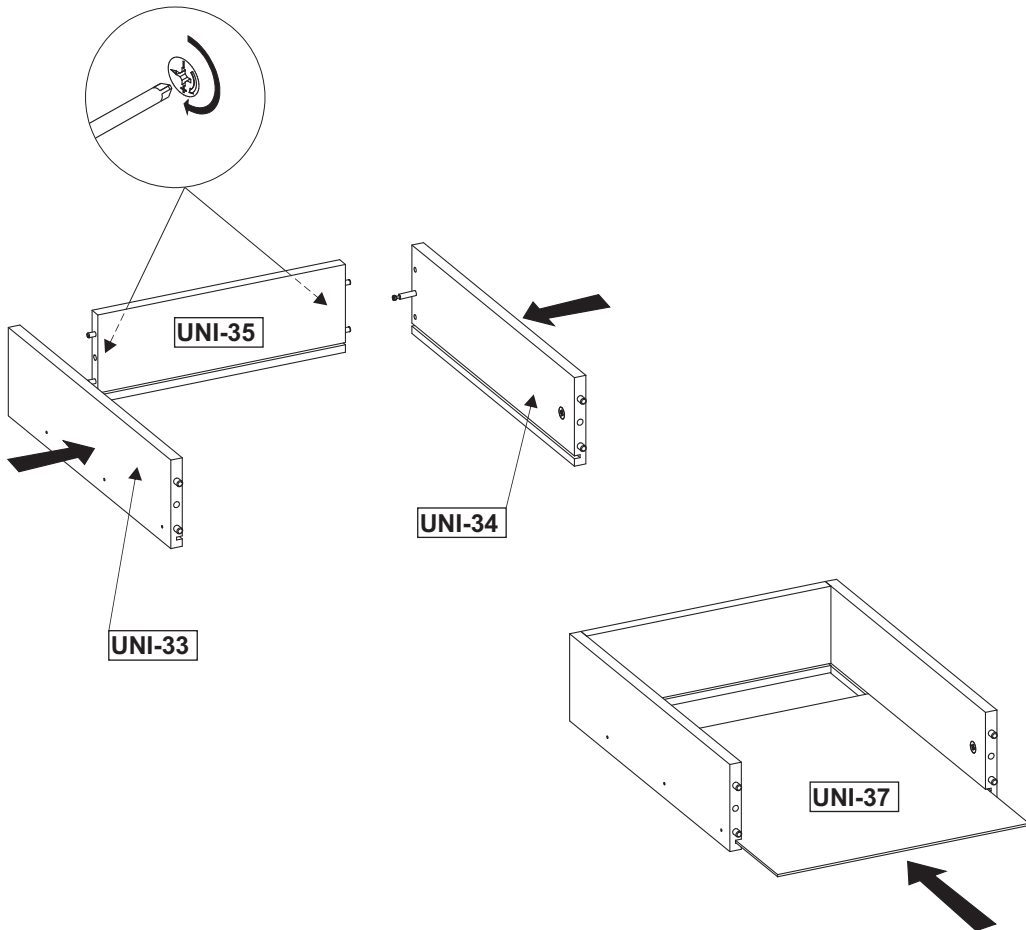

# 2



- 2x  C
- 4x  E

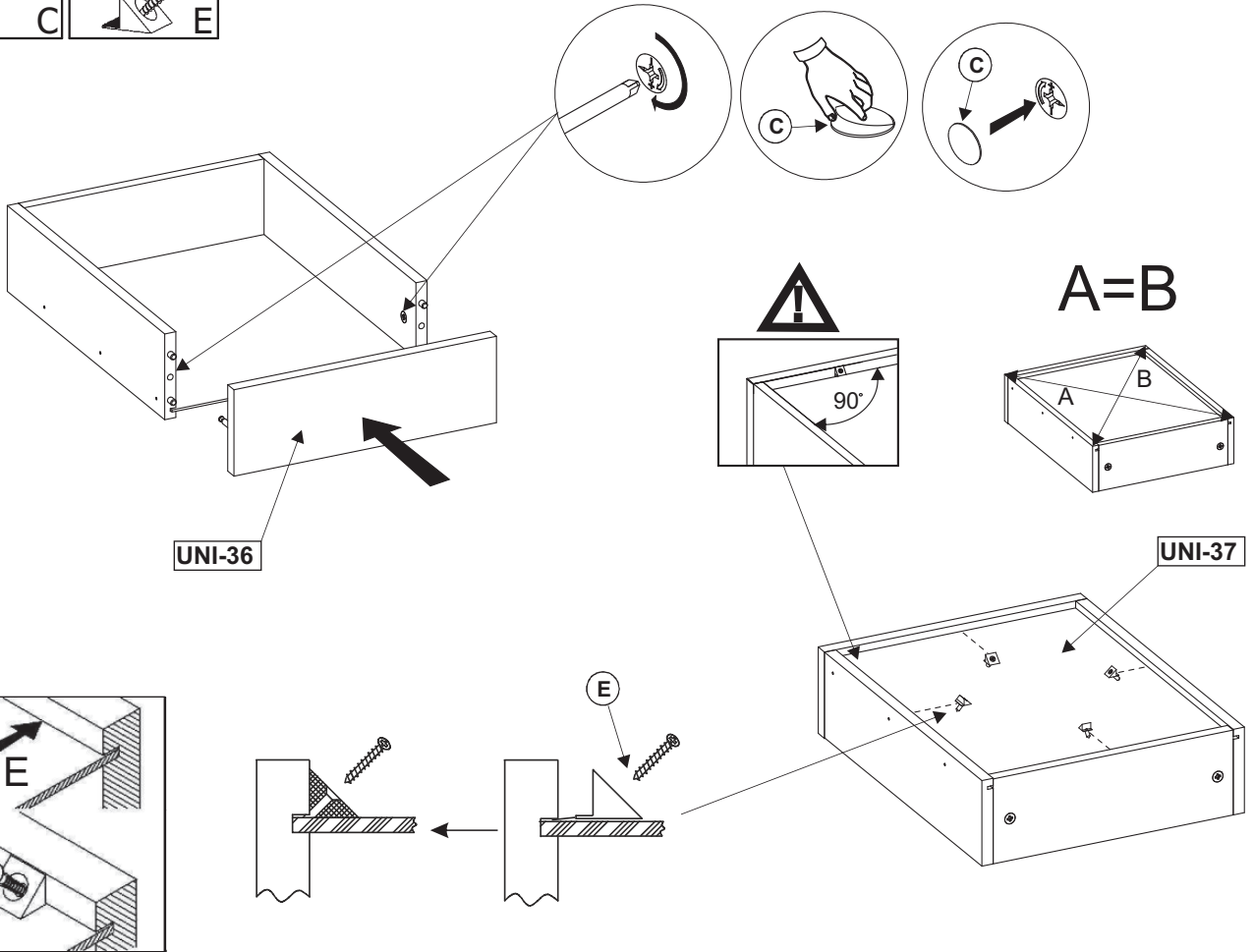

- 2x  I

