



(GB) Assembly instructions

(PL) Instrukcja montażu

(DE) Montageanleitung

(CZ) Montážní návod

(FR) Notice de montage

(SK) Návod na montáž

(NL) Handleiding voor de montage

(HR) Montaža

(IT) Istruzioni di montaggio

(TR) Montaj talimat

(HU) Szerelési útmutató

(RO) Instrucțiuni de montaj

(ES) Instrucciones de montaje

(RU) Инструкция по монтажу

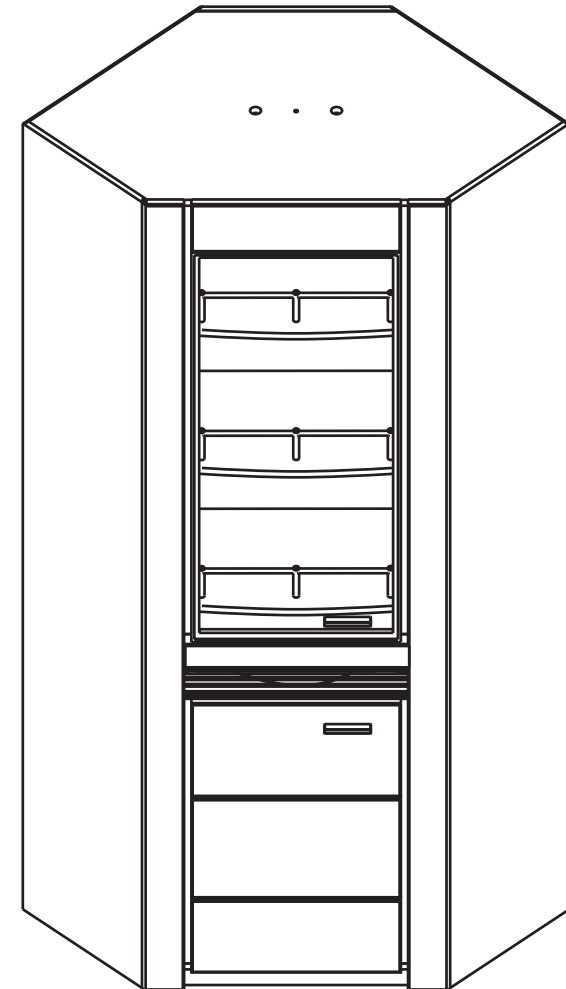
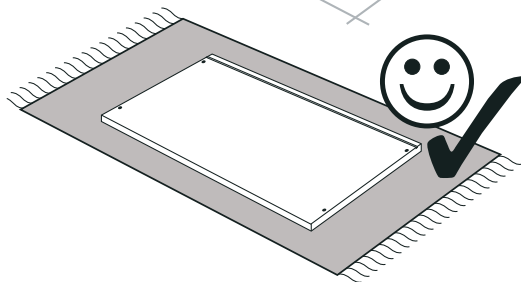
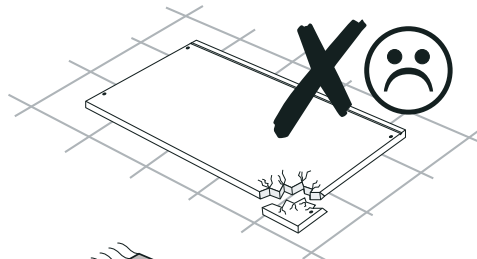
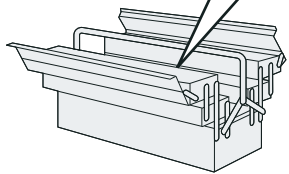
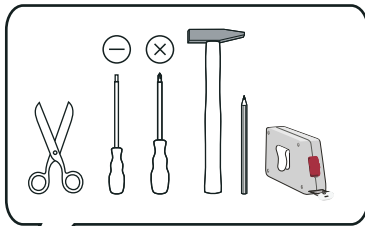
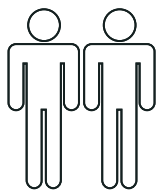

Service • Assistenza • Dienstverlening • Serwis Servis • Szerviz • Servizio • Usluga • Сервисная Служба

Name • Nom • Nome • Naam • Nazwa
Jméno • Název • Név • Denimire
Nombre • Ime • Isim • Название

VELVET

shop • geschäft • boutique • sklep • winkel • магазин
negozio • bolt • tienda • obchod • dučan • mađaza • magazin

Nr. • No. • N° • Номер • И • Sz • Ne

SIDR26..

Typ • Type • Tip • Típus • Тíро • Тип

11

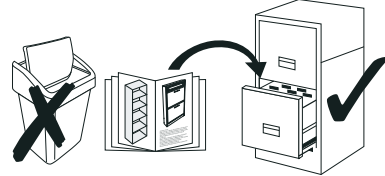
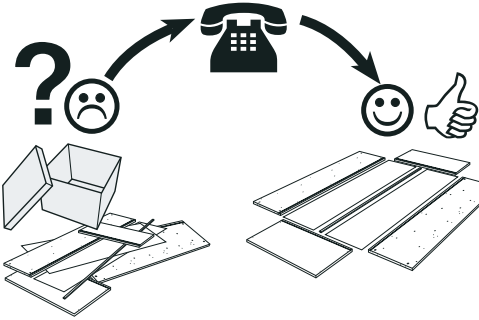

Z25 KR 90 	T1 	B30 115x20x20 X... 	B31 54x20x20 X...
Z26 KR 90 	T2 M6 X... 	B29 54x20x25 X... 	U81 C1883 G5 96 mm X...
Z26 <i>cichy domyk</i> KR 90 	M1 	S12 4x30 X... 	A2 M4x25 X...
D19 H 6 X... 	B1 φ 8x28 X... 	J11 	R1 83x14 X...
D21 H 3 X... 	F15 	T17 φ 8 4x45 X... 	R2 83x14 X...
E1 6,3x14 X... 	W1 	P13 3,5x13 X... 	R3 M4x25 X...
S9 4x16 X... 	C9 φ 20 X... 	P6 4x35 X... 	R4
P2 3x16 X... 	O55 534mm 	Q1 M4x10 X... 	R5
S10 3,5x25 X... 	L2 SJ X... 		
C5 φ 5 X... 			

0 10 20 30 40 50 60 70 80 90 100 110 120 130 140 150 160 170 180 190 200

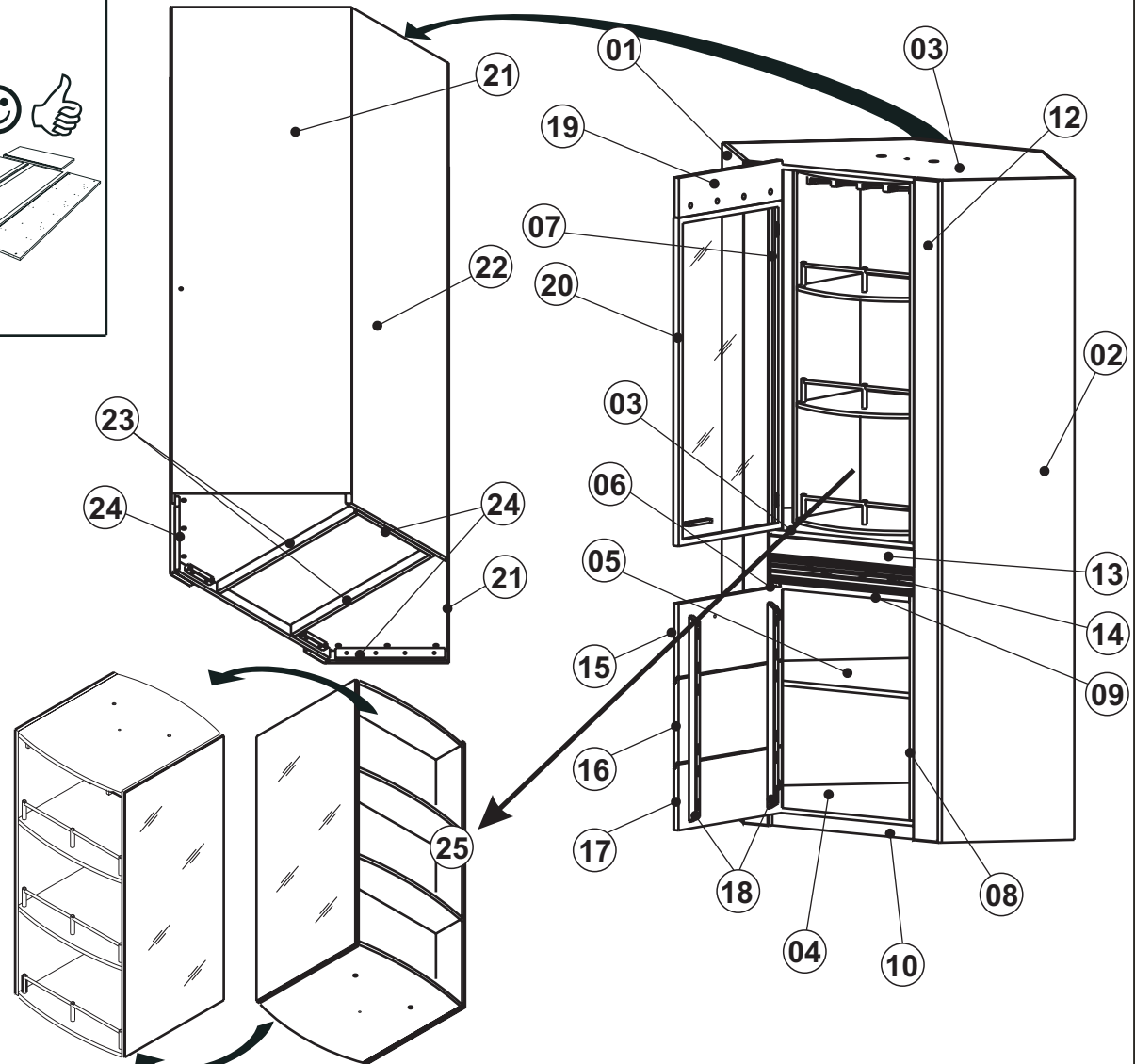
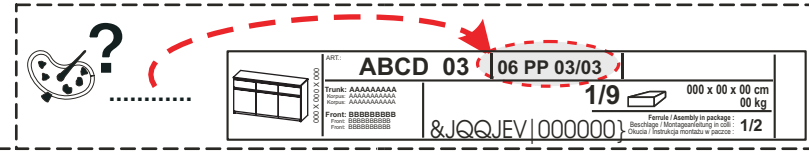

1

F15  x12

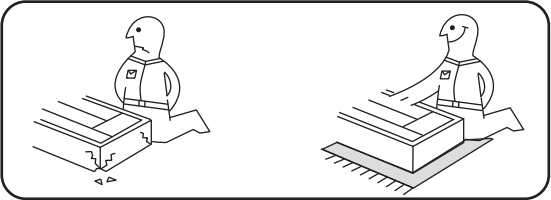
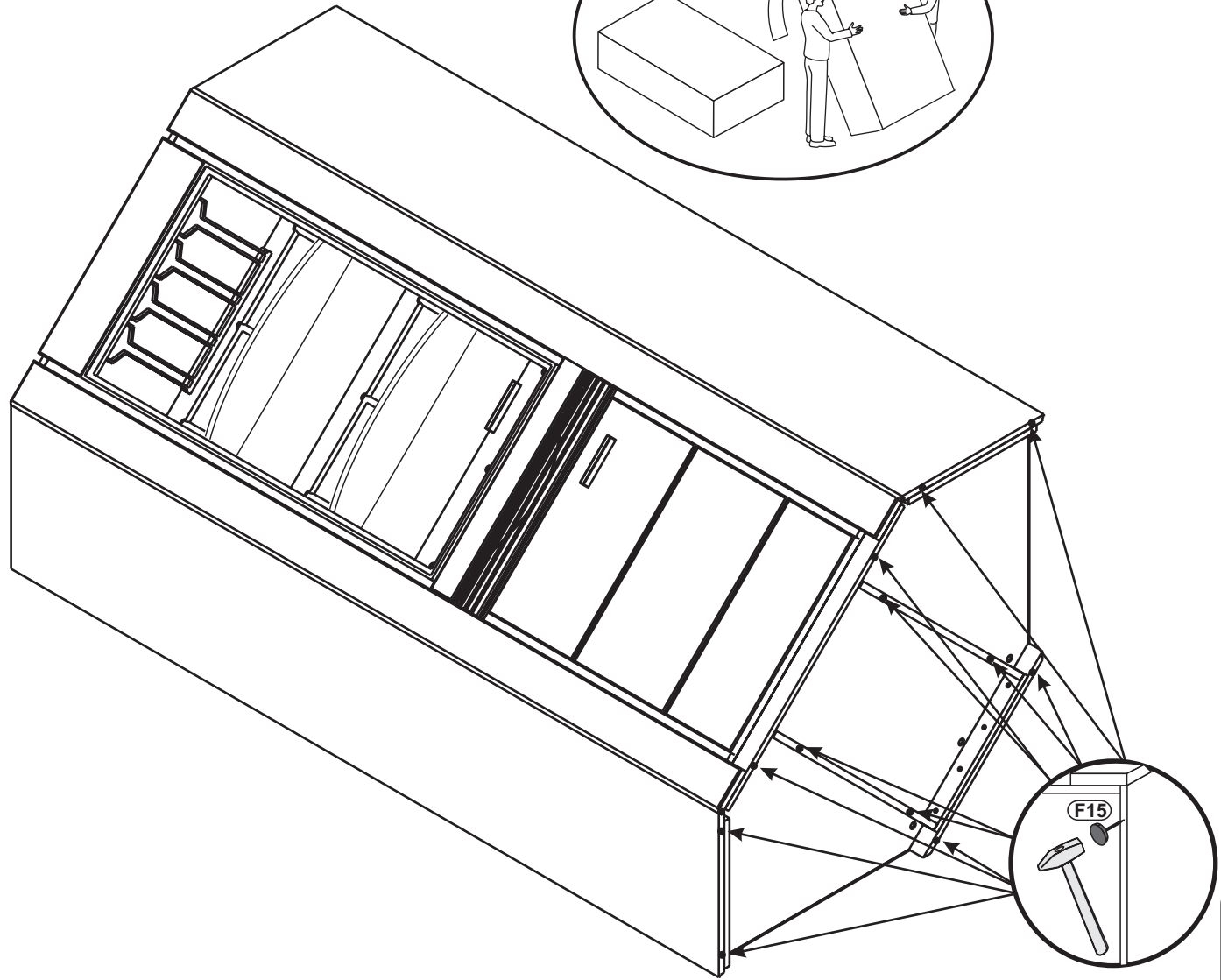
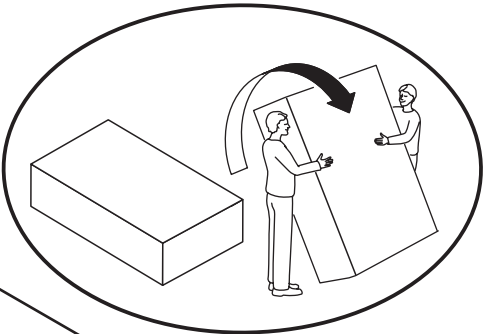

2

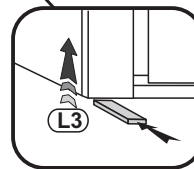
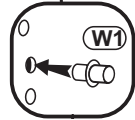
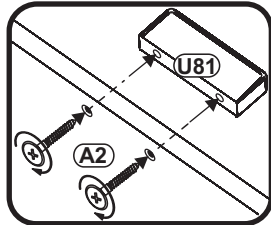
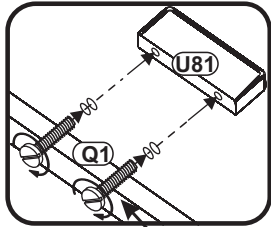
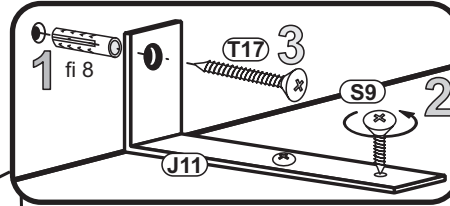
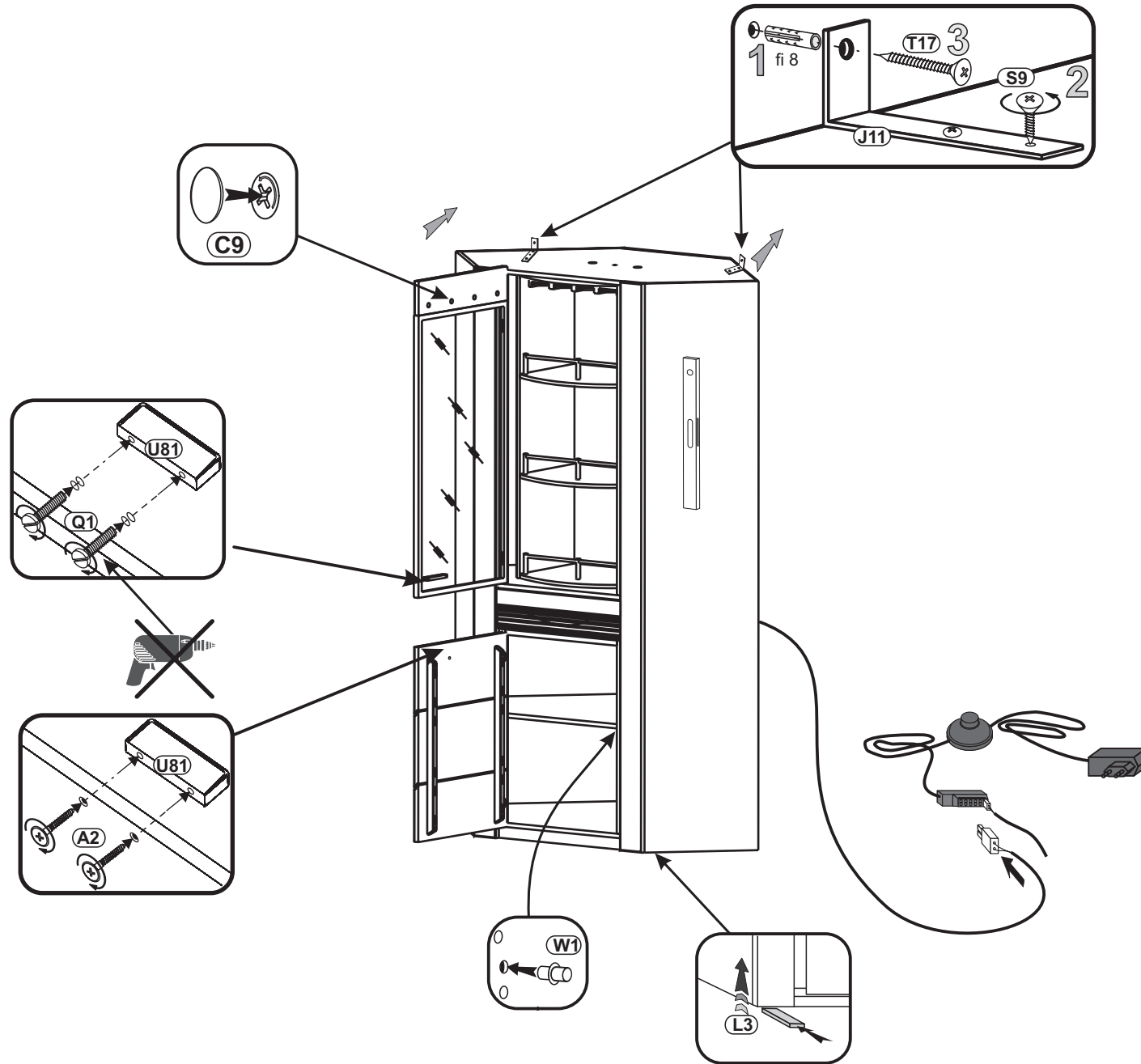

- U81** C1883 G5 96 mm x2
- A2** M4x25 x2
- Q1** M4x10 x2
- W1** x6
- C9** φ 20 x4
- J11** x2
- T17** φ 8 4x45 x2
- S9** 4x16 x4
- L3** 45x15 x6

